



HM Government

fire safety risk assessment

open air events and venues

Copyright in the contents, the cover, the design and the typographical arrangement rests with the Crown. This document/publication is value added. If you wish to re-use this material, please apply for a Click-Use Licence for value added material at www.opsi.gov.uk/click-use/system/online/pLogin.asp

Alternatively applications can be sent to:

OPSI, Information Policy Team, St Clements House, 2-16 Colegate, Norwich NR3 1BQ

Fax: 01603 723000

E-mail: HMSOLicensing@cabinet-office.x.gsi.gov.uk

This publication has been approved by Ministers and has official status. The contents of this publication may be reproduced free of charge in any format or medium for the purposes of private research and study or for internal circulation within an organisation. This is subject to the contents being reproduced accurately and not in a way that implies official status. Any publisher wishing to reproduce the content of this publication must not use or replicate the HMG logo or replicate the official version's style and appearance, including the design, and must not present their publication as being an official publication as this may confuse the public. The reproduced material must be acknowledged as Crown Copyright and the title of the publication specified. HM Government does not accept any responsibility for the accuracy and the comprehensiveness of any other versions.

Any other use of the contents of this publication would require a copyright licence. Further information can be obtained from www.opsi.gov.uk

Department for Communities and Local Government Publications
PO Box 236
Wetherby
West Yorkshire
LS23 7NB
Tel: 0870 830 7099
Fax: 0870 1226 237
Textphone: 0870 1207 405
E-mail: communities@twoten.com

This document is also available on the Communities and Local Government website: www.firesafetyguides.communities.gov.uk

Reference number: 05 FRSD 03338 (i)

Published by the Department for Communities and Local Government, Eland House, Bressenden Place
London SW1E 5DU, February 2007.

© Crown Copyright 2007.

Printed on material containing 100% post-consumer waste (text), 75% post-consumer waste and 25% ECF pulp (cover).

ISBN-13: 978 1 85112 823 5

Contents

How to use this guide	2
Preface	3
Introduction	4
Part 1 Fire risk assessment	10
Step 1 Identify fire hazards	14
Step 2 Identify people at risk	16
Step 3 Evaluate, remove, reduce and protect from risk	17
Step 4 Record, plan, inform, instruct and train	34
Step 5 Review	40
Part 2 Further guidance on fire risk assessment and fire precautions	43
Section 1 Further guidance on fire risks and preventative measures	44
Section 2 Further guidance on fire-detection and warning systems	55
Section 3 Further guidance on firefighting equipment and facilities	58
Section 4 Further guidance on escape routes and strategies	63
Section 5 Further guidance on emergency escape lighting	78
Section 6 Further guidance on signs and notices	80
Section 7 Further guidance on recording, planning, informing, instructing and training	83
Section 8 Quality assurance of fire protection equipment and installation	93
Appendix A Example fire safety maintenance checklist	94
Appendix B Example form for recording significant findings	97
Appendix C Technical information on fire-resisting separation, fire doors and door fastenings	98
Appendix D Glossary	103
References	107
Further reading	111
Index	113

How to use this guide

This guide is divided into two parts:

- **Part 1** Explains what a fire risk assessment is and how you might go about it. Fire risk assessments should be the foundation for all the fire precautions in your premises.
- **Part 2** Provides further guidance on fire precautions. The information is provided for you and others to dip into during your fire risk assessment or when you are reviewing your precautions.

This guide is one from a series of guides listed on the back cover.

The appendices provide example checklists, some detailed technical information on fire resisting elements, case studies definitions, glossary and references.

The rest of this introduction explains how the law applies.

Technical terms are explained in the glossary and references to other publications listed at the end of the publication are identified by a superscript number in the text.

In this guide reference is made to British Standards and standards provided by other bodies. The standards referred to are intended for guidance only and other standards could be used. Reference to any particular standard is not intended to confer a presumption of conformity with the requirements of the Regulatory Reform (Fire Safety) Order 2005¹ (the Order).

The level of necessary safety (or service) must be dictated by the findings of your risk assessment so you may need to do more or less than that specified in any particular standard referred to. You must be prepared to show that what you have done complies with any requirements or prohibitions of the Order¹ irrespective of whether you have relied on a particular standard.

A full list of references, e.g. ¹, can be found at the back of this book.

Preface

This guidance gives advice on how to avoid fires and how to ensure people's safety if a fire does start. Why should you read it? Because:

- Fire kills. In 2004, (England and Wales) fire and rescue services attended over 33,400 fires in non domestic buildings. These fires killed 38 people and injured over 1,300.
- Fire costs money. The costs of a serious fire can be high and afterwards many businesses do not reopen. In 2004, the costs as a consequence of fire, including property losses, human casualties and lost business, were estimated at £2.5bn.

This guide applies to England and Wales only. It does not set prescriptive standards, but provides recommendations and guidance for use when assessing the adequacy of fire precautions for open air events and venues. Other fire risk assessment methods may be equally valid to comply with fire safety law. The guide also provides recommendations for the fire safety management of the premises.

Your existing fire safety arrangements may not be the same as the recommendations used in this guide but, as long as you can demonstrate that they meet an equivalent standard of fire safety, they are likely to be acceptable. If you decide that, your existing arrangements are not satisfactory there may be other ways to comply with fire safety law. This means there is no obligation to adopt any particular solution in this guide if you prefer to meet the relevant requirement in some other way.

Where buildings have been recently constructed or significantly altered, the fire detection and warning arrangements, escape routes and facilities for the fire and rescue service may have been designed, constructed and installed in accordance with current building regulations.² In such cases, it is likely that these measures will be satisfactory as long as they are being properly maintained and no significant increase in risk has been introduced.

This guide should not be used to design fire safety for new buildings. Where alterations are proposed to existing buildings, as they may be subject to building regulations². However, it can be used to develop the fire safety strategy for your premises.

Introduction

WHO SHOULD USE THIS GUIDE?

This guide is for all employers, managers, organisers of events, occupiers, and owners of open air events and venues. It tells you what you have to do to comply with fire safety law, helps you to carry out a fire risk assessment and identify the general fire precautions you need to have in place.

This guide is intended for open air events, and venues, such as

- theme parks,
- zoos,
- music concerts and festivals,
- sporting events,
- race meetings,
- fairgrounds,
- street festivals,
- religious festivals,
- balloon festivals,
- car-boot sales,
- county fairs, and
- other similar events.

This guide does not cover sports stadia, permanent buildings or structures, large temporary structures and air-supported structures. Where your event or venue includes the use of these, reference should be made to the appropriate guides in this series (see back cover for other guides in this series).

The guide has been written to provide guidance for a responsible person to help them to carry out a fire risk assessment of less complex open air events or venues. If you read the guide and decide that you are unable to apply the guidance, then you should seek advice from a competent person.

More complex premises will probably need to be assessed by a person who has comprehensive training or experience in fire risk assessment. However this guide can be used at a large event to address fire safety issues within a specific area such as a marquee.

It may also be useful for:

- employees;
- volunteers and volunteer organisations;

- employee-elected representatives;
- trade union-appointed health and safety representatives;
- enforcing authorities;
- all other people who have a role in ensuring fire safety in open air events and similar venues.

Where you handle and store flammable materials and substances, this guide will help you take account of these in your risk assessment and help you determine the necessary precautions required to minimise the likelihood of them being involved in a fire.

Fire safety is just one of many safety issues management must address to minimise the risk of injury or death to staff and the public unlike most of the other safety concerns, fire has the potential to injure or kill large numbers of people very quickly. This guidance is concerned with fire safety only, but many of the measures discussed here will impact upon other safety issues and therefore it is recognised that these differing safety demands can sometimes affect one another and management should consult other interested agencies (e.g. Health and Safety Executive (HSE)), where necessary, to confirm that they are not contravening other legislation/guidance.

You can get advice about minimising fire losses from your insurer.

THE FIRE SAFETY ORDER

Previous general fire safety legislation

The Order¹ replaces previous fire safety legislation. Any fire certificate issued under the Fire Precautions Act 1971³ will cease to have any effect. If a fire certificate has been issued in respect of your premises or buildings on the premises were built to recent building regulations², as long as you have made no material alterations and all the physical fire precautions have been properly maintained, then it is unlikely you will need to make any significant improvements to your existing physical fire protection arrangements to comply with the Order.¹ However, you must still carry out a fire risk assessment and keep it up to date to ensure that all the fire precautions in your premises remain current and adequate.

If you have previously carried out a fire risk assessment under the Fire Precautions (Workplace) Regulations 1997,⁴ as amended 1999,⁵ and this assessment has been regularly reviewed, then all you will need to do now is revise that assessment taking account of the wider scope of the Order¹ as described in this guide.

Your premises may also be subject to the provisions of a licence or registration (e.g. under the Licensing Act 2003⁶), and the fire authority may wish to review your risk assessment as part of the licensing approval process. Fire safety conditions within your premises licence should not be set by a licensing authority where the Order¹ applies.

If your venue is used for sporting events you need to be aware of safety at sports grounds legislation (e.g. The Safety of Sports Grounds Act 1975)⁹⁰ which might apply (see The Guide to Safety at Sports Grounds).¹¹

Background

The Order¹ applies in England and Wales. It covers 'general fire precautions' and other fire safety duties which are needed to protect 'relevant persons' in case of fire in and around most 'premises'. The Order¹ requires fire precautions to be put in place 'where necessary' and to the extent that it is reasonable and practicable in the circumstances of the case.

Responsibility for complying with the Order¹ rests with the 'responsible person'. In a workplace, this is the employer and any other person who may have control of any part of the premises, e.g. occupier or owner, manager. In all other premises the person or people in control of the premises will be responsible. If there is more than one responsible person in any type of premises, all must take all reasonable steps to co-operate and co-ordinate with each other.

If you are the responsible person, you must carry out a fire risk assessment, which must focus on the safety in case of fire of all 'relevant persons'. It should pay particular attention to those at special risk, such as disabled people, those who you know have special needs and children, and must include consideration of any dangerous substance liable to be on the premises. Your fire risk assessment will help you identify the risks that can be removed or reduced, and to decide the nature and extent of the general fire precautions you need to take.

If your organisation employs five or more people, your premises are licensed or an alterations notice is in force, you must record the significant findings of the assessment. It is good practice to record your significant findings in any case.

There are other fire safety duties you need to comply with:

- **You must** appoint one or more 'competent persons', depending on the size and use of your premises, to carry out any of the preventative and protective measures required by the Order¹ (you can nominate yourself for this purpose). A competent person is someone with enough training and experience or knowledge and other qualities to be able to implement these measures properly.
- **You must** provide your employees / volunteers with clear and relevant information on the risks to them identified by the fire risk assessment, about the measures you have taken to prevent fires, and how these measures will protect them if a fire breaks out.
- **You must** consult your employees (or their elected representatives) about nominating people to carry out particular roles in connection with fire safety and about proposals for improving the fire precautions.

- **You must**, before you employ a child, provide a parent with clear and relevant information on the risks to that child identified by the risk assessment, the measures you have put in place to prevent/protect them from fire and inform any other responsible person of any risks to that child arising from their undertaking.
- **You must** inform non-employees, such as residents, temporary or contract workers, of the relevant risks to them, and provide them with information about who are the nominated 'competent persons' and about the fire safety procedures for the premises.
- **You must** co-operate and co-ordinate with other responsible persons who also have premises in the open air event or venue, inform them of any significant risks you find and how you will seek to reduce/control those risks, which might affect the safety of their employees.
- **You must** provide the employer of any person from an outside organisation who is working in your premises (e.g. agency providing temporary staff) with clear and relevant information on the risks to those employees and the preventative and protective measures taken. You must also provide those employees with appropriate instructions and relevant information about the risks to them.
- If you are not the employer but have any control of premises which contain more than one workplace, **you are also responsible** for ensuring that the requirements of the Order¹ are complied with in those parts over which you have control.
- **You must** consider the presence of any dangerous substances and the risk this presents to relevant persons from fire.
- **You must** establish a suitable means of contacting the emergency services and provide them with any relevant information about dangerous substances.
- **You must** provide appropriate information, instruction and training to your employees, during their normal working hours, about the fire precautions in your workplace, when they start working for you, and from time to time throughout the period they work for you.
- **You must** ensure that the premises and any equipment provided in connection with fire-fighting, fire detection and warning, or emergency routes and exits are covered by a suitable system of maintenance and are maintained by a competent person in an effective manner, in efficient working order and in good repair.
- **Your employees must** co-operate with you to ensure the workplace is safe from fire and its effects, and must not do anything that will place themselves or other people at risk.

The above examples outline some of the main requirements of the Order¹. The rest of this guide will explain how you might meet these requirements.

Responsibilities for short term hiring or leasing and for shared use

Some premises or parts of premises may be leased as an empty and unsupervised facility (e.g. temporary structures and marquees). The fire safety responsibilities of those leasing the premises (and, therefore, in charge of the activities conducted within the premises), and those of the owner/lessee, need to be established as part of the contract of hire.

In some premises (e.g. race meetings), part of the premises may be hired out to another organisation for a separate function (e.g. a catering facility or hospitality area). The fire safety responsibilities of those leasing that part of the premises (and, therefore in charge of the activities conducted there) and those of the owner/leasee, need to be established as part of the contract of hire.

The responsible person for each individual unique, occasional or separate event or function will need to be clearly established and documented, and their legal duties made clear to them: In particular, and where necessary, the responsible person will need to take account of their own lack of familiarity with the layout of the premises, the fire safety provisions and the duties of other responsible persons within the premises.

Who enforces the Fire Safety Order?

The local fire and rescue authority (the fire and rescue service) will enforce the Order¹ in most premises. The exceptions are:

- Crown-occupied/owned premises where Crown fire inspectors will enforce;
- premises within armed forces establishments where the defence fire and rescue service will enforce;
- certain specialist premises including construction sites, ships (under repair or construction) and nuclear installations, where the Health and Safety Executive (HSE) will enforce, and
- sports grounds and stands designated as needing a safety certificate by the local authority, where the local authority will enforce.

The enforcing authority will have the power to inspect your premises to check that you are complying with your duties under the Order¹. They will look for evidence that you have carried out a suitable fire risk assessment and acted upon the significant findings of that assessment. If you are required to record the outcome of the assessment and they will expect to see a copy.

If the enforcing authority is dissatisfied with the outcome of your fire risk assessment or the action you have taken, they may issue an enforcement notice that requires you to make certain improvements or, in extreme cases, a prohibition notice that restricts the use of all or part of your premises until improvements are made.

If your premises are considered by the enforcing authority to be, or have the potential to be, high risk, they may issue an alterations notice that requires you to inform them before you make any changes to your premises or the way they are used.

Failure to comply with any duty imposed by the Order¹ or any notice issued by the enforcing authority is an offence. You have a right of appeal to a magistrate's court against any notice issued. Where you agree that there is a need for improvements to your fire precautions but disagree with the enforcing authority on the technical solution to be used (e.g. what type of fire alarm system is needed) you may agree to refer this for an independent determination.

If having read this guide you are in any doubt about how fire safety law applies to you, contact the fire safety office at your local fire and rescue service.

If your premises were in use before 2006, then they may have been subject to the Fire Precautions Act³ and the Fire Precautions (Workplace) Regulations.^{4,5} Where the layout (means of escape) and other fire precautions have been assessed by the fire and rescue service to satisfy the guidance that was then current, it is likely that your premises already conform to many of the recommendations here, providing you have undertaken a fire risk assessment (and kept it up to date as required by the Fire Precautions (Workplace) Regulations.^{4,5}

New buildings or significant building alterations should be designed to satisfy current building regulations² which address fire precautions. However, you will still need to carry out a fire risk assessment, or review your existing one (and act on your findings), to comply with the Order.¹

Part 1 Fire risk assessment

MANAGING FIRE SAFETY

Good management of fire safety is essential to ensure that fires are unlikely to occur; that if they do occur they are likely to be controlled quickly, effectively and safely or that if a fire does occur and grow, to ensure that everyone in your premises are able to escape to a place of total safety easily and quickly.

Good management of fire safety at a temporary or permanent open air event or venue will help to ensure that any fire safety matters that arise will always be addressed effectively. Therefore identification of the 'responsible person' is imperative.

Planning

It is of fundamental importance to appreciate that planning for effective fire safety for an open air event, site or venue should start at the same time as the planning for all other aspects of the proposed event.

The planning issues for an event, site or venue can be considered in a number of stages:

- venue design, selection of workers, selection of contractors and subcontractors, construction of the stages, marquees, fencing, (the 'build up');
- safe delivery and installation of equipment and services which will be used at the event, e.g. stage equipment used by the performers, lighting, and the protection of crew, (the 'load in');
- effective fire safety during the event ('the event');
- safe removal of equipment and services, (the 'load down');
- control fire risks once the event is over and the infrastructure is being dismantled, (the 'breakdown');

The risk assessment that you must carry out will help you to ensure that your fire safety procedures, fire prevention measures, and fire precautions (plans, systems, and equipment) are all in place and working properly, and the risk assessment should identify any issues that need attention. Further information on managing fire safety is available in Part 2 on page 43.

EXAMPLES OF FIRE AT OPEN AIR EVENTS

Prior to stepping through the risk assessment process, it is worth noting some examples of fires at open air events. There have been a number of cases of severe fires over the last 50 years, many of which have resulted in a significant loss of life. Table 1 below provides examples of a small number of these fires, covering fatal and non-fatal fires from different countries.

Description	Venue type	Ignition	Fuel	Additional comments
Religious camp, Mecca	Camp	Gas stove	Tents	Dry conditions, closely placed tents, 400 deaths
Hartford, Connecticut	Circus	Unknown	Main circus tent	Gasoline and paraffin waterproofing of tent canvas caused fast flame spread, 163 deaths
Thorpe Park, UK	Fairground	Unknown	Timber structures & fair rides	Evacuation strategy and fire service intervention resulted in no deaths
Movieworld, Australia	Theme park	Unknown	Gas and chemical mix	Unexplained explosion in the pyrotechnics compound, 3 injuries, no deaths
Niteroi Circus, Brazil	Circus	Arson	Tent & circus materials	Fire started by disgruntled employee, 323 deaths
Edgewater Park, Detroit	Theme park	Lightning	Wooden structures	400 people escaped from the wooden structure when the fire started, 2 deaths
Kenilworth, SA	Racecourse	Unknown	Dry neighbouring field and vehicles	Fire spread from field to car park, where 131 vehicles completely burnt out, no deaths

Table 1: Examples of fires at open air events

WHAT IS A FIRE RISK ASSESSMENT?

A fire risk assessment is an organised and methodical look at your premises and/or event, the activities carried on there and the likelihood that a fire could start and cause harm to those in and around the premises.

The aims of the fire risk assessment are:

- To identify the fire hazards.
- To reduce the risk of those hazards causing harm to as low as reasonably practicable.
- To decide what physical fire precautions and management arrangements policies are necessary to ensure the safety of people in your premises if a fire does start.

The term ‘where necessary’ (see Glossary) is used in the Order¹, therefore when deciding what fire precautions and management arrangements are necessary, you will need to take account of this definition.

The terms ‘hazard’ and ‘risk’ are used throughout this guide and it is important that you have a clear understanding of how these should be used.

- **Hazard:** Anything that has the potential to cause harm.
- **Risk:** The chance of that harm occurring.

If your organisation employs five or more people, or your premises are licensed or an alterations notice requiring it is in force, then the significant findings of the fire risk assessment, the actions to be taken as a result of the assessment and details of anyone especially at risk must be recorded. You will probably find it helpful to keep a record of the significant findings of your fire risk assessment even if you are not required to do so.

HOW DO YOU CARRY OUT A FIRE RISK ASSESSMENT?

A fire risk assessment will help you determine the chances of a fire starting and the dangers from fire that your premises present for the people who use them and any person in the immediate vicinity. The assessment method suggested in this guide shares the same approach as that used in general health and safety legislation and can be carried out either as part of a more general risk assessment or as a separate exercise. As you move through the steps there are checklists to help you.

Before you start your fire risk assessment, take time to prepare, and read through the rest of Part 1 of this guide.

Much of the information for your fire risk assessment will come from the knowledge that your employees, colleagues, volunteers and representatives have of the premises, including experience gained from previous events, as well as information given to you by people who have responsibility for other parts of the premises. A tour of your site will probably be needed to confirm, amend or add details to your initial views.

It is important that you carry out your fire risk assessment in a practical and systematic way and that you allocate enough time to do a proper job. It must take the whole of your premises into account, including areas that may be infrequently used. If your premises are small you may be able to assess them as a whole. In some premises you may find it helpful to divide them into a series of assessment areas using natural boundaries, e.g. staging areas, sports fields, spectator areas marquees and concessions.

If your premises are in a multi-use venue then the information on hazard and risk reduction will still be applicable to you. However, any alterations to your individual part of the premises will need to take account of the overall fire safety arrangements in the complex, venue or event.

Your premises may be simple, with few people present or with a limited degree of entertainment activity. However, if your site stages an event, which will have a range of different occupiers (e.g. concessions) then the measures provided by the other occupiers may have a direct effect on the fire safety measure of the overall site.

Under health and safety law (enforced by the HSE or local authority) you are required to carry out a risk assessment in respect of any work processes in your workplace and to take or observe appropriate special, technical or organisational measures. If your health and safety risk assessment identifies that these processes are likely to involve the risk of fire or the spread of fire then you will need to take this into account during your fire risk assessment under the Order¹, and prioritise actions based on the level of risk.

You need to appoint one or more 'competent persons' (this could be you) to carry out any of the preventive and protective measures needed to comply with the Order¹. This

person could be you, or an appropriately trained employee, or where appropriate, a third party.

Your fire risk assessment should demonstrate that, as far as is reasonable, you have considered the needs of all relevant people including disabled people.

Figure 1 shows the five steps you need to take to carry out a fire risk assessment.

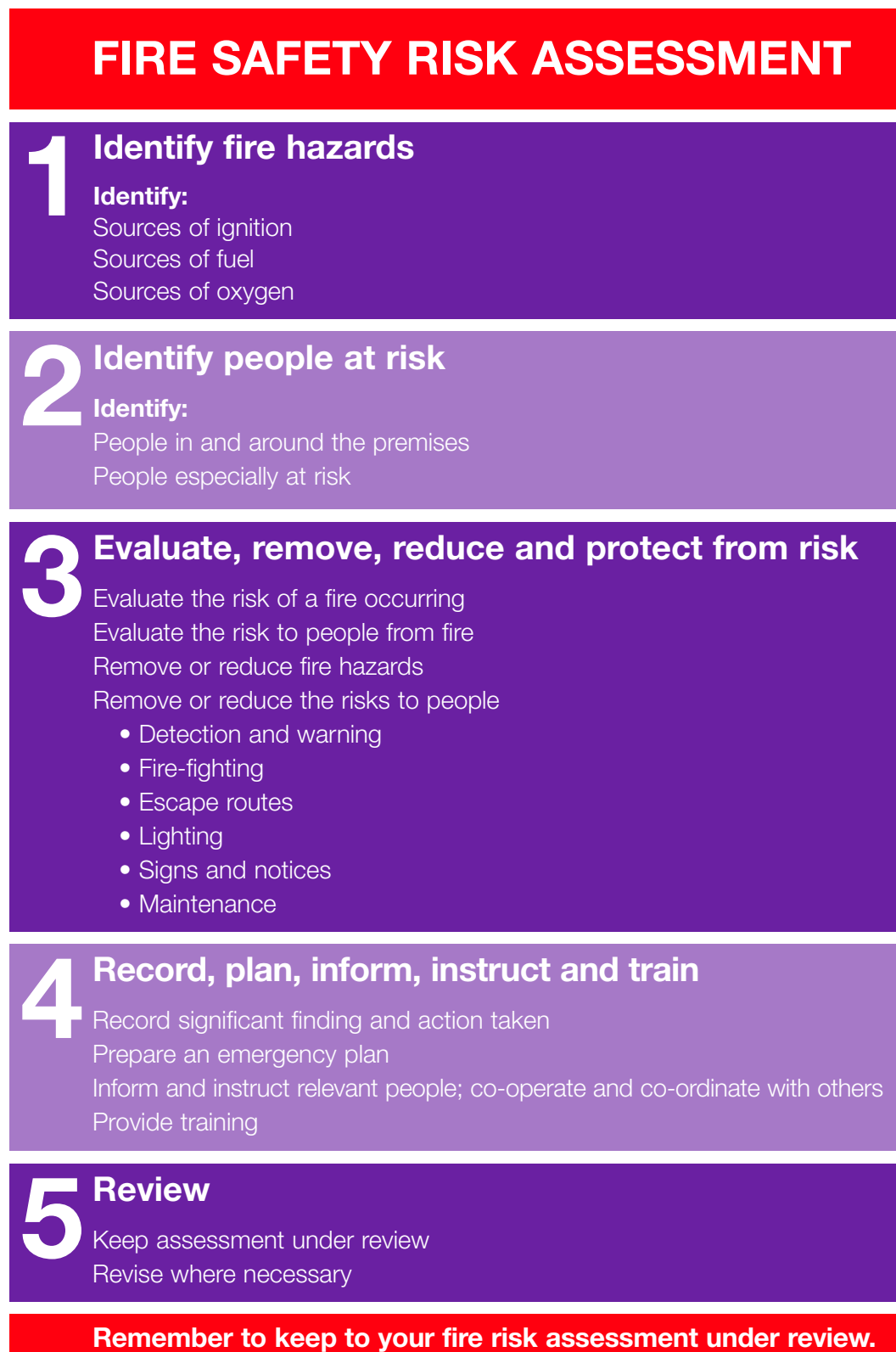

Figure 1: The five steps of a fire risk assessment

STEP 1 IDENTIFYING FIRE HAZARDS

For a fire to start, three things are needed:

- a source of ignition;
- fuel; and
- oxygen.

If any one of these is missing, a fire cannot start. Taking measures to avoid the three coming together will, therefore, reduce the chances of a fire occurring.

The remainder of this step will advise on how to identify potential ignition sources, the materials that might fuel a fire and the oxygen supplies that will help it to burn.

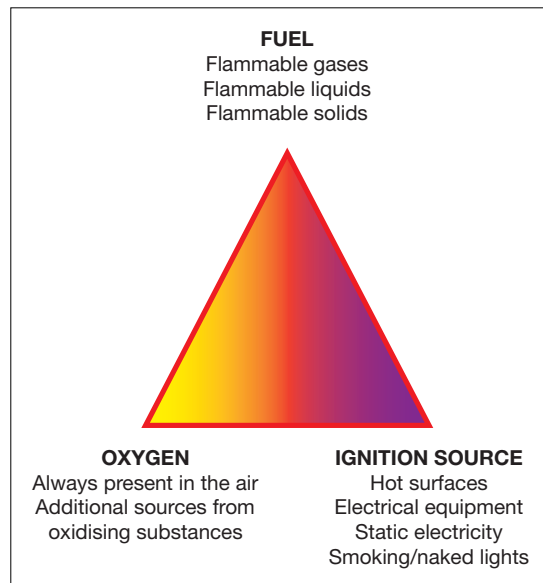

Figure 2: The fire triangle

1.1 Identify sources of ignition

You can identify the potential ignition sources at your event or venue by looking for possible sources of heat, which could get hot enough to ignite material found in your premises. These sources could include:

- cooking and catering appliances and equipment, including barbecues;
- smokers materials, e.g. cigarettes, matches and lighters;
- camp fires/bonfires;
- electrical, gas or oil-fired heaters (fixed or portable);
- hot processes, e.g. welding by contractors, blacksmiths;
- faulty or misused electrical equipment;
- light fittings and lighting equipment, e.g. halogen lamps or display lighting;
- hot surfaces and obstruction of equipment ventilation, e.g. generators;
- naked flames, e.g. candles or gas or liquid-fuelled open-flame equipment;
- flares, fireworks and pyrotechnics;
- deliberate ignition (e.g. arson, vandalism);
- refuelling;
- natural phenomena (e.g. lightning);

- mechanical friction (e.g. fairground rides)
- vehicle catalytic converters.

Indications of ‘near-misses’ (e.g. scorch marks on tents / marquees, discoloured or charred electrical plugs and sockets, cigarette burns, etc) can help you identify hazards which you may not otherwise notice.

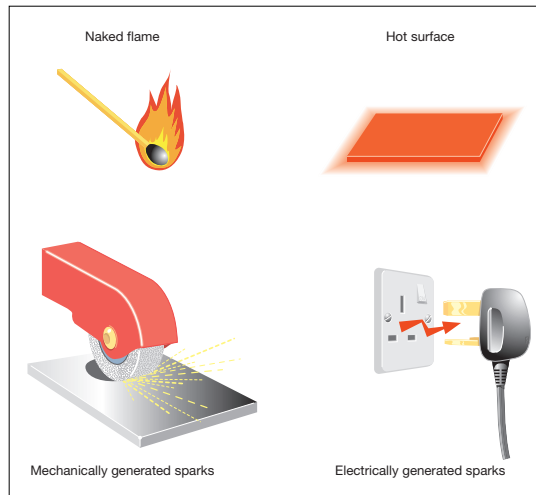

Figure 3: Sources of ignition

1.2 Identify sources of fuel

Anything that burns is fuel for a fire. You need to look for the things that will burn reasonably easily and are in enough quantity to provide fuel for a fire or cause it to spread to another fuel source. Some of the most common ‘fuels’ found at open air events or venues are:

- flammable liquids and solvents, e.g. cleaning products, alcohol (spirits), white spirit, methylated spirit, cooking oils, disposable cigarette lighters, fuel for generators (whether petrol or diesel), paints, varnishes, thinners and adhesives;
- flammable gases e.g. liquefied petroleum gas (LPG) propane and acetylene;
- displays and stands,
- tents and marquees;
- plastics and rubber, e.g. polyurethane foam-filled furniture and polystyrene-based display materials;
- upholstered seating and cushions, textiles and soft furnishings, such as hanging curtains and clothing displays, costumes, drapes and hangings, scenery and banners;
- packaging materials, litter and waste products, particularly finely divided items e.g. stationery, advertising material, decorations, shredded paper and wood shavings, timber off cuts, and dust;
- fireworks and pyrotechnics;
- animal feed, animal bedding; vegetation (e.g. long grass);
- temporary floor coverings;
- pallets used to transport goods;
- vehicles in the venue or at car parks.

You should also carefully consider brought in materials that might introduce an unanticipated source of fuel and how they might contribute to the spread of fire.

Further information is available in Part 2 Section 1

1.3 Identify sources of oxygen

The main source of oxygen for a fire is in the air around us. In an enclosed building this is provided by the ventilation system in use. This generally falls into one of two categories: natural airflow through doors, windows and other openings; or mechanical air conditioning systems and air handling systems. In many buildings there will be a combination of systems, which will be capable of introducing/extracting air to and from the building. Events and venues open to the air have no such restrictions and additionally are more likely to be affected by high winds that may increase the fire growth rate and fire spread. Sources of oxygen can sometimes be found in materials used or stored on the site such as:

- Some chemicals (oxidising materials) which can provide a fire with additional oxygen and so help it burn. These chemicals should be identified on their container (and control of substances hazardous to health data sheet, see Figure 4) by the manufacturer or supplier who can advise as to their safe use and storage;
- Oxygen supplies from cylinder storage.
- Pyrotechnics and fireworks which contain oxidising materials and need to be treated with great care.



Figure 4: Label on oxidising materials

Checklist



- Have you identified all potential ignition sources?
- Have you identified all potential fuel sources?
- Have you identified all potential sources of oxygen?
- Have you recorded your findings?

STEP 2 IDENTIFYING PEOPLE AT RISK

As part of your fire risk assessment, you need to identify those people at risk if there is a fire. To do this, you need to identify who will be present at your premises, where people are working, either at permanent locations (e.g. ticket desks, catering facilities, hospitality areas, fairground rides, music stages) or at occasional locations around the site and consider who else may be at risk, (e.g. spectators, customers, visiting performance companies, visiting contractors) and where these people are likely to be found.

You must consider all the people who use the site or venue but you should pay particular attention to people who may be especially at risk. These include:

- employees and volunteers who work alone, e.g. security staff;
- people who are unfamiliar with the site, e.g. visitors and customers, new employees;
- people with a disability* (including mobility, hearing or vision impairment) or those who may have some other reason for not being able to leave the site quickly. e.g. people in a state of undress (stage performers), or parents with children;
- unaccompanied children and young persons;
- people with a language difficulty or who's first language is not English;
- people with sensor impairment due to alcohol, drugs or medication;
- those responsible for animal safety and evacuation during a fire;
- other people in the vicinity of your event or venue
- In evaluation the risk to people with disabilities you may need to discuss their individual needs with them. For larger events and venues used extensively by the public you may need to seek professional advice.

Further guidance on people with special needs is given in Part 2, Section 1.11.

Checklist



- Have you identified who is at risk?
- Have you identified why they are at risk?
- Have you recorded your findings?

STEP 3 EVALUATE, REMOVE, REDUCE AND PROTECT FROM RISK

The management of the premises and the way people use it will have an effect on your evaluation of risk. Management may be your responsibility alone or there may be others, such as the owners of the site or organisers of the events, who also have responsibilities. At multi-occupancy sites or events all those with some control must co-operate: you need to consider the risk generated by others on the site.

3.1 Evaluate the risk of a fire occurring

The likelihood of a fire starting may be low if there are few ignition sources and combustible materials are kept away from them.

In general, fires start in one of three ways:

- accidentally, such as when smoking materials are not properly extinguished or when display lights are knocked over;
- by act or omission, such as when electrical equipment is not properly maintained or disposable barbecues are placed into waste bins containing combustibles.

* Visit the Disability Rights Commission website on www.drc-gb.org for more information.

- deliberately, such as an arson attack involving setting fire to rubbish bins placed too close to temporary structures such as tents or marquees;

Look critically at your event or venue and try to identify any 'accidents waiting to happen' and any acts or omissions which might allow a fire to start. You should also look for any situation that may present an opportunity for an arsonist.

Further information on evaluating the risk of fire starting is available in Part 2, Section 1.

3.2 Evaluate the risk to people

In Step 2 you identified the people likely to be at risk should a fire start anywhere at your event or venue and earlier in step 3 you identified the chances of a fire occurring.

It is unlikely that you will have concluded that there is no chance of a fire occurring anywhere at your premises so you now need to evaluate the actual risk to those people present should a fire start and spread from the various locations that you have identified.

When considering the possible incidents that might occur, you should also consider the likelihood of any particular incident occurring, but be aware that some very unlikely incidents can put many people at risk.

To evaluate the risk to people at your premises, you will need to understand the way fire can spread. Fire is spread by three methods:

- convection;
- conduction; and
- radiation.

Convection

Fire spread by convection is the most dangerous and causes the largest number of injuries and deaths. When fires start in enclosed spaces, such as temporary buildings, the smoke rising from the fire gets trapped by the ceiling and then spreads in all directions to form an ever-deepening layer over the entire room or space. The smoke will pass through any holes or gaps in the walls, ceiling and floors into other parts of the building. The heat from the fire gets trapped in the enclosures and the temperature rises.

In open air the risk of fire spread due to convection will be mainly confined to the movement of hot embers.

Conduction

Some materials, such as metal, can absorb heat and transmit it to an adjoining space, where it can set fire to combustible items that are in contact with the heated material.

Radiation

Radiation heats the air in the same way as an electric bar heater heats a room. Any material close to a fire will absorb the heat until the item starts to smoulder and then burn.

Smoke produced by a fire also contains toxic gases which are harmful to people. In most cases, the greatest contributor to the risk to people is whether they are in the open air or in an enclosure where smoke can spread quickly, block exits, and affect people's ability to escape.

It is essential that the means of escape and other fire precautions are adequate to ensure that everyone can make their escape to a place of total safety before the fire and its effects can trap them.

In evaluating the risk to people, you will also need to consider situations such as:

- the evacuation of large numbers of people, e.g. a music concert or festival;
- fire and smoke spread from fires external to your event/venue, such as grass fires affecting occupant means of escape;
- a fire developing in an unoccupied space, such as a storage area in a hospitality unit, that people have to pass to escape;
- fire spreading rapidly between concession stands due to their close proximity with each other and presence of combustible materials;
- rapid fire spread in areas with highly combustible piled storage, e.g. bails of hay;
- fire and smoke spreading due to poor installation of fire precautions, e.g. incorrectly installed fire doors or incorrectly installed services penetrating fire walls;
- the impacts of fences or corralling on the movement of people;
- hazardous materials present.

Further guidance on fire risks is given in Part 2 Section 1.

3.3 Remove or reduce the hazards

Having identified the fire hazards in Step 1, you now need to remove those hazards if it is reasonably practicable to do so. If you cannot remove the hazards, you need to take reasonable steps to reduce them if you can. This is an essential part of the fire risk assessment and as a priority, this must take place before any other actions.

Ensure that any actions you take to remove or reduce fire hazards are not substituted by other hazards or risks. For example, if you replace a flammable substance with a toxic or corrosive one, you must consider whether this might cause harm to people in other ways.

Remove or reduce sources of ignition

There are various ways that you can reduce the risk caused by potential sources of ignition, for example:

- ensure that flares and fireworks are not brought into the event or venue by members of the public;
- ensure that all pyrotechnics, fireworks, flares and other hazardous equipment are installed, used, maintained, protected and stored in accordance with the manufacturer's instructions;
- wherever possible replace a potential ignition source by a safer alternative;
- replace naked flame and radiant heaters with fixed convector heaters. Restrict the movement of and guard portable heating appliances;
- restrict/control the use of naked flames e.g. campfires, barbecues, candles;
- operate a safe smoking policy;
- ensure electrical, mechanical and gas equipment is installed, used, maintained, and protected in accordance with the manufacturer's instructions;
- ensure cooking and catering equipment is installed, used, maintained, and protected in accordance with the manufacturer's instructions;
- control areas where vehicles are parked;
- take precautions to avoid arson.

Remove or reduce sources of fuel

There are various ways that you can remove or reduce the risks caused by materials and substances, which burn, for example:

- ensure that display materials (including artificial and dried foliage), props, scenery and stands, are fire retardant, or have been treated to give some fire retardancy;
- reduce stocks of flammable materials, liquids and gases on display in public areas to a minimum. Keep remaining stock in dedicated storerooms or storage areas where the public are not allowed to go, and keep the minimum amount required for the operation of the business;
- ensure that all upholstered furniture, curtains, drapes, tents and marquees, are fire retardant, or have been treated to give some fire retardancy;
- ensure safe practice with respect to refuelling generators. Use of petrol generators should be discouraged, wherever possible, in favour of diesel generators;
- develop a formal system for the control of combustible waste by ensuring that waste materials and rubbish are not allowed to build up and are carefully stored until properly disposed of, particularly at the end of the day;
- ensure adjacent marquees, temporary structures and other fire hazards are sited an adequate distance apart;
- ensure scenery and props not in current use on an open stage are stored away in an approved scenery or prop store.

- ensure that the quantity of all pyrotechnics, fireworks and other hazardous equipment are kept to a minimum. Additionally ensure that they are stored safely and securely until they are used;
- take action to avoid any parts of the event or venue, being vulnerable to arson or vandalism;
- reduce the risk of grass/moorland fires by providing fire breaks and keeping grass short.

Further guidance on removing and reducing hazards is given in Part 2, Section 1.

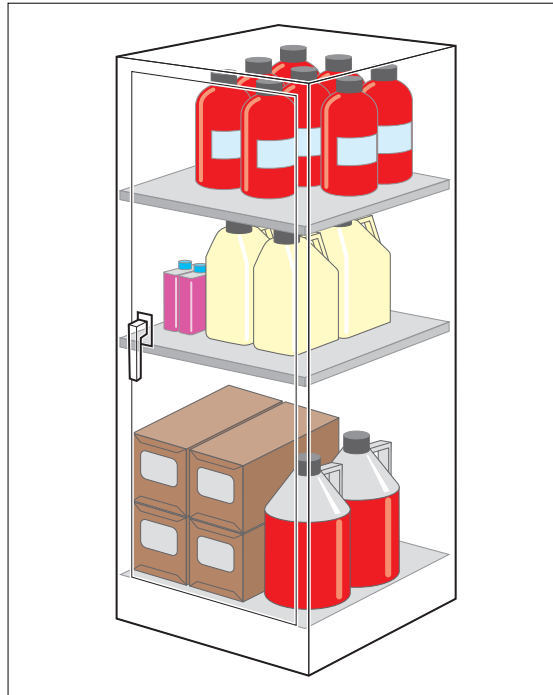

Figure 5: Storage of flammables

Remove or reduce sources of oxygen

You can reduce the potential source of oxygen supplied to a fire by:

- not storing oxidising materials near any heat source or flammable materials;
- controlling the use and storage of oxygen cylinders, ensuring that they are not leaking;
- controlling the use and storage of pyrotechnics and fireworks.

3.4 Remove or reduce the risks to people

Having evaluated and addressed the risk of fire occurring and the risks to people (preventative measures) it is unlikely that you will have concluded that no risk remains of fire starting and presenting a risk to people at your premises.

You now need to reduce any remaining fire risk to people to as low as reasonably practicable by ensuring that adequate fire precautions are in place to warn people in the event of a fire and allow them to safely escape.

The rest of this step describes the fire protection measures you may wish to adopt to reduce the remaining fire risk to people (see steps 3.4.1 to 3.4.6).

The level of fire protection you need to provide will depend on the level of risk that remains in the premises after you have removed or reduced the hazards and risks.

Part 2, Section 4 can help you decide the level of risk that you may still have.

Flexibility of fire protection measures

Flexibility will be required when considering this guidance; the level of fire protection should be proportional to the risk posed to the safety of the people at your premises. Therefore, the objective should be to reduce the remaining risk to a level that is as low as reasonably practicable. The higher the risk of fire and risk to life, the higher the standards of fire protection will need to be.

Your fire precautions may not exactly fit the solutions suggested in this guide and they may need to be applied in a flexible manner without compromising the safety of people.

For example, if the travel distance in a marquee is in excess of the norm (see Part 2, Table 5 on page 70) it may be necessary to do any one or a combination of the following to compensate:

- Provide earlier warning of fire using automatic fire detection
- Revise the layout to reduce travel distances
- Reduce the fire risk by removing or reducing combustible materials and/or ignition sources
- Control the number of people in the marquee
- limit the area to trained staff/volunteers only (no public)
- Increase staff/volunteer training and awareness

Note: The above list is not exhaustive and is only used to illustrate some examples of trade-offs to provide a safer event or venue.

If you decide to significantly, vary away from the benchmarks in this guidance you should seek expert advice before doing so.

3.4.1 Fire detection and warning systems

The means of giving a warning of fire should be suitable for the particular event or venue, taking account of its size, layout, number of people likely to be present and the nature of the event.

In some small events/venues the only practicable solution for people to raise an alarm upon the discovery of a fire could be a simple shout of 'fire' or a simple manually operated device, such as a gong or air horn that can be heard by everybody. At larger or more complex sites a public address system is likely to be the most effective means of providing a warning and directing the evacuation. Organisers/staff will need a managed fire evacuation plan to facilitate this.

For permanent buildings or temporary tents/marquees where a simple warning is not sufficient, an electrical warning system may be required incorporating sounders and manually operated call points (break – glass boxes).

Where there are areas where a fire could develop to the extent that escape routes could be affected before the fire is discovered, an automatic fire detection system may be necessary.

At complex events/venues, particularly those accommodating people in different areas, (e.g. a zoo), it is likely that a more sophisticated form of warning and evacuation, possibly phased may be required.

Where the provision of a system connected by cables may not be appropriate, a radio signal based system should be considered.

You may need to consider special arrangements for times when people are working alone are disabled, or when your normal occupancy patterns are different, e.g. when maintenance staff or other contractors are working at the weekend / night or people are attending to horses at night during a county show.

It is important to consider the means of communication between staff and volunteers implementing the emergency plan.

Large campsites should normally be provided with fire watchtowers and campers should be provided with fire safety advice.

If you are not sure whether your current arrangements are adequate, see the additional guidance on fire warning systems in Part 2, Section 2.

Checklist



- Can the means of detection ensure a fire is discovered quickly enough for the alarm to be raised in time for all the occupants to escape to a place of total safety?
- Can appropriate means of warning be clearly heard, and/or seen, and understood by everyone throughout the whole site, event, or venue?
- If the fire-detection and warning system is powered electrically, does it have a back-up power supply?
- Have the public address systems been checked before the event?

3.4.2 Fire-fighting equipment and facilities

Fire-fighting equipment can reduce the risk of a small fire, e.g. a fire in a waste-paper bin, developing into a large one. The safe use of an appropriate fire extinguisher to control a fire in its early stages can also significantly reduce the risk to other people in the event or venue by allowing people to assist others who are at risk.

The provision of fire-fighting equipment for outdoor events will vary according to the local conditions and what is brought on to the site. You should consider the need for equipment for tackling fires in vegetation, vehicles, and marquees.

Arrangements may need to be made to protect fire-fighting equipment located outdoors from the effects of frost, vandalism, and theft.





Main types of portable extinguishers, their uses and colour coding			
<p>WATER For wood, paper, textile and solid material fires</p> 	<p>POWDER For liquid and electrical fires</p> 	<p>FOAM For use on liquid fires</p> 	<p>CARBON DIOXIDE (CO₂) For liquid and electrical fires</p> 
<p>DO NOT USE on liquid, electrical or metal fires</p>	<p>DO NOT USE on metal fires</p>	<p>DO NOT USE on electrical or metal fires</p>	<p>DO NOT USE on metal fires</p>
<p>The contents of an extinguisher is indicated by a zone of colour on the red body. Halon extinguishers are not shown since no new Halon production is permitted in the UK</p>			

Figure 6: Types of fire extinguishers

At small sites or venues, having one or two portable extinguishers of the appropriate type, readily available for use, may be all that is necessary.

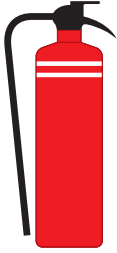
At complex sites or venues where a number of portable extinguishers are required they should be sited in suitable locations. Extinguishers should also be sited adjacent to, but not near to, fire hazards. It may also be necessary to indicate the location of extinguishers by suitable signs.

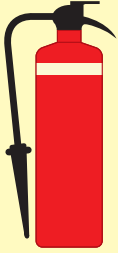
Fire blankets may also be appropriate for use on your site and their installation should be considered for higher risk areas, e.g. catering facilities.

Some sites or venues may have permanently installed fire-fighting equipment. Other fixed installations and facilities to assist fire fighters, such as 'fire' water mains may also have been provided.

People with no training should not be expected to attempt to extinguish a fire. However, all staff and where appropriate volunteers, should be familiar with the location and basic operating procedures for the equipment provided. If your fire strategy requires that certain people, e.g. fire marshals, will be expected to take a more active role, then, they should be provided with more comprehensive training.

At some events an independent specialist fire team may be employed. Where this is the case the use of an all terrain vehicle may be necessary to enable them to reach all areas, especially where camping areas are provided. A protocol should be agreed between the event organisers, fire and rescue service and fire team to define responsibilities, actions and reporting procedures.

Facilities for fire fighting also include the access routes for fire and rescue service and other emergency service vehicles. At all outdoor venues you must ensure that you have provided adequate and appropriate vehicle access to all parts of the venue. You should also consider how these routes would be affected by the people at your site or event.

For more guidance on portable fire extinguishers see Part 2, Section 3.1, for fixed fire points, Part 2, Section 3.2 and other facilities (including those for firefighters) see Part 2 Section 3.3.

Checklist



- Are the portable fire extinguishers or any fixed firefighting equipment provided suitable for controlling the risks identified?
- Are there enough extinguishers sited throughout the premises at appropriate locations?
- Are the right types of extinguishers located close to the fire hazards and can users get to them without exposing themselves to risk?
- Are the extinguishers visible or does their position need indicating?
- Do you regularly check equipment provided to help maintain the escape routes?
- Do you carry out daily checks to ensure that there is clear access for fire engines?
- Are those who test and maintain the equipment competent to do so?
- Do you have the necessary procedures in place to maintain any facilities that have been provided for the safety of people in the building (or for the use of firefighters, such as access for fire engines and firefighting lifts)?

3.4.3 Escape Routes

Once a fire has started, been detected and a warning given, everyone at your venue or event should be able to escape to a place of total safety unaided and without the help of the fire and rescue service. However, some people with disabilities & others with special needs may need assistance from other people.

Escape routes should be designed to ensure, as far as possible, that any person confronted by fire, is able to turn away from it and escape to a place of reasonable safety, e.g. outside of a marquee. From here, they will be able to go directly to a place of total safety.

The level of fire protection that should be given to escape routes will vary depending on the level of risk of fire within the premises and other related factors. Generally simple enclosures found at open air events & venues will require fairly simple measures to protect escape routes compared to more complex (permanent buildings).

When determining whether your event or venue has adequate escape routes, you need to consider a number of factors, including;

- the type & number of people present at the event or venue and their distribution around the site
- the number and size of exits from marquees and other enclosures and from outdoor areas, e.g. in any fences, hedges or other barriers around the site.
- exits and gateways are unlocked and staffed by stewards throughout the event;
- all exits and gateways are clearly indicated by suitable signs which are illuminated if necessary;
- the occupants are directed to all available exits so that their evacuation is without delay;
- identify an area/field as a designated place of total safety, which may be within the site boundaries, to which people are evacuated;
- the designated place of safety does not place people at undue risk from other sources, e.g. vehicles on a busy road.

At the planning stage, consult the local fire and rescue service about the proposals for means of escape.

The type and number of people using the event or venue

The people present at your event or venue will sometimes be entirely employees (outside of opening hours), but will most of the time be a mixture of employees, volunteers and members of the public. Employees can reasonably be expected to have an understanding of the layout of the site or venue while members of the public, particularly in more complex sites, will be unlikely to have knowledge of any escape routes.

The number of people present will influence your assessment of the requirements for escape routes. You must ensure that your escape routes are sufficient to enable the maximum number of people likely to use your event or venue at any time to escape safely. If necessary, you may need to increase the size and/or number of the escape routes or restrict the number of people on site, as appropriate.

In considering the numbers of people present, you need to take account of the type of event. If it is a ticketed event you will be able to determine the maximum number of people attending the event and provide adequate escape routes. If your event is 'free' admission, determining the maximum number will be more difficult and it may be influenced by factors such as the weather. In this case, you may have to consider monitoring the number of people entering the site, control entry numbers, control the numbers within specific areas, and/or preventing migration and overcrowding. You may also need to take account of the possible effects of intoxicants (e.g. alcohol, drugs) on people and other behavioural issues such as parents seeking their children and people reluctant to abandon property.

Escape time

In the event of fire it is important to evacuate people as quickly as possible from the locality of the fire. The time available to do this will depend on a number of factors, including:

- the location of the fire (indoor/outdoor);
- how quickly the fire is detected and the alarm raised;
- the number of people present;
- the type of people present;
- the number and location & width of exits/gateways;
- the presence of features that restrict the flow of people;
- the speed of fire growth;
- the size of your site, event or venue; and
- topographical features such as sloping ground and conditions underfoot.

The escape time for open air areas will have a range of values and the time for your site or venue will be unique. Guidance on the range of values relative to the risk to the people present is provided in Part 2, Section 4. Reference should also be made to *The Guide to Safety at Sports Grounds*¹¹ and *The Event Safety Guide*¹⁰ for further guidance on escape times.

Escape times in indoor situations, e.g. marquees and other enclosed structures, are more critical and are controlled by restricting the travel distances to exits. For simplicity, time factors are taken into account in the travel distances suggested in Part 2, Table 5.

Number and suitability of escape routes

Every venue should be provided with exits that are sufficient for the number of people present with respect to their width, number and siting.

From a marquee or other enclosures there should usually be at least two escape routes available but a single escape route may be acceptable in some circumstances (e.g. part of your premises accommodating less than 60 people or where travel distances are limited). Where two escape routes are necessary and to further minimise the risk of people becoming trapped, you should ensure that the exit routes are completely independent of each other. This will prevent a fire affecting more than one exit route at the same time.

When evaluating escape and exit routes, you will normally need to build in a safety factor by discounting the largest exit from your escape plan then determine whether the remaining exits or escape routes will be sufficient to evacuate all the occupants within a reasonable time. Exits and escape routes that provide escape in a single direction only may need additional fire precautions to be regarded as adequate.

Exit doors or gates on escape routes should normally open in the direction of travel, and be quickly and easily openable without the need for a key.

Management of escape routes

It is essential that escape routes, and the means provided to ensure they are used safely, are managed and maintained to ensure that they remain usable and available at all times when the public are present on the site

Inform staff and volunteers, in training sessions about the escape routes within the site. Escape routes should be kept clear and hazard free at all times. Arrangements should be made to prevent external escape routes from becoming obstructed by vehicles, stalls etc. Items that may be a source of fuel or pose an ignition risk should never be located close to an escape route (e.g. from a tent or marquee).

Emergency evacuation of persons with mobility impairment

The means of escape you provide must be suitable for the evacuation of everyone likely to be at your event or venue. People with a disability are often not able to leave the site or venue quickly. This may be the result of mobility, hearing, vision or other impairment. Similarly, those who may have some other reason for not being able to leave the site quickly, e.g. people in a state of undress (stage performers), elderly customers, or parents with children should be considered separately. This may require additional planning and allocation of staff roles – with appropriate training.

Use of these facilities will need to be linked to effective management arrangements as part of your emergency plan. The plan should not rely on fire and rescue service involvement for it to be effective.

Further guidance on escape routes is available in Part 2, Section 4.



Checklist

- Can all the occupants escape to a place of reasonable or total safety in a reasonable time?
- Are the exits in the right place and do the escape routes lead as directly as possible to a place of total safety?
- Are the escape routes adequate for the numbers and type of people that may need to use them? e.g. members of the public, including disabled people.
- If there is a fire, could all available exits be affected or will at least one route from any part of the site or venue remain available?
- Where appropriate, have you identified the assembly areas and are they in the appropriate location?
- Will everybody be able to safely use the escape routes?
- Can all exit doors and gates be opened easily and immediately if there is an emergency?
- Have restrictions to the flow of people been considered and where necessary, removed?
- Are arrangements in place to keep all escape routes & exit clear?

3.4.4 Emergency Escape Lighting

People at your event or venue must be able to find their way to a place of total safety if there is a fire by using escape routes that have enough lighting. If some of your escape routes are internal and without windows, or your venue is used during periods of darkness, then, some form of back-up to the normal escape route lighting (emergency escape lighting) should be provided.

For simple venues or events with very small numbers of people, suitably placed torches for use by trained staff or volunteers may be acceptable.

At larger sites or venues it is likely that a more comprehensive system of automatic emergency escape lighting will be needed to illuminate the escape routes and you should consult with a suitably qualified person for the type and specification of installation required.

Where your event or venue is entirely in the open and it is attended during the hours of darkness, you need to consider the provision of emergency escape lighting throughout the site to illuminate all areas where people are accommodated and the escape routes to places of reasonable and total safety.

Further guidance on emergency escape lighting is given in Part 2, Section 5.



Checklist

- Will your event take place or your venue be used during the hours of darkness.
- Are all the escape routes sufficiently illuminated for use at all times people are present.
- Have you provided emergency escape lighting by means of either an independent back-up power supply to the normal lighting or by means of separate lighting with an independent source of power.

3.4.5 Signs and notices

Signs

Signs must be used, where necessary, to help people identify escape routes/exits, find fire-fighting equipment and emergency fire telephones. These signs are required under the Health and Safety (Safety Signs and Signals) Regulations 1996^{7,8} and must comply with the provisions of those Regulations.

For a sign to comply with the Regulations, it must be in pictogram form (see Figure 7). Text and directional arrows can supplement the pictogram if this is considered necessary to make the sign easily understood, but you must not have a safety sign that uses text only.

A fire risk assessment that determines that no escape signs are required (because, for example, trained staff will always be available to help direct members of the public to escape routes) is unlikely to be acceptable to an enforcing authority other than in the smallest and simplest of premises e.g. a small marquee with a single entrance.

The extent of escape signage provided will depend on the size of your event and the ease with which people can locate the exits. If the location of exits is obvious from any point, signs located above the exits are likely to be sufficient. If exits are not apparent, additional signs, which direct the people present to the exits, will be required. You must also consider the size of the signage provided.

Where the locations of escape routes and fire-fighting equipment are readily apparent and the fire-fighting equipment is visible at all times, e.g. within a temporary or permanent building, then signs are not necessary. In all other situations it is likely that the fire risk assessment will indicate that signs will be necessary.



Figure 7: Typical fire exit sign

Notices

Notices must be used, where necessary, to provide the following:

- Instructions on how to use any fire safety equipment
- The actions to be taken in the event of fire
- To help the fire and rescue service (e.g. to show the location of fire water mains?)

Where your site or venue is used during periods of darkness all signs and notices should be illuminated by a suitable lighting installation.

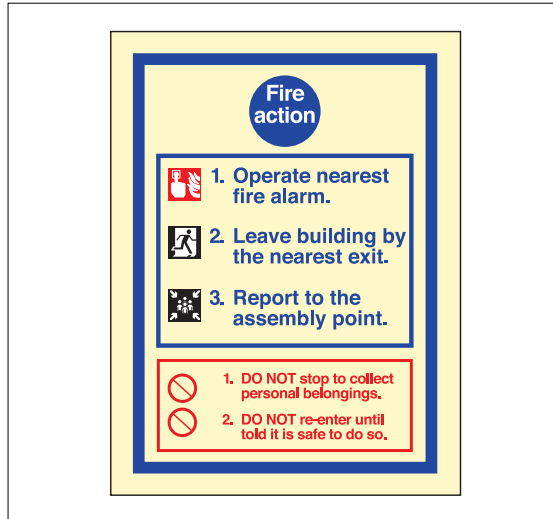

Figure 8: Simple fire action notice

All signs and notices should be positioned so that they can be easily seen and understood.

Further guidance on signs and notices is given in Part 2, Section 6.



Checklist

- When necessary are escape routes, exits, the locations of fire-fighting equipment and emergency fire telephones indicated by appropriate signs?
- Are you maintaining all the necessary signs and notices so that they continue to be correct, legible and understood?
- Are you maintaining signs that you have provided for the information of the fire and rescue service?

3.4.6 Installation testing and maintenance

New fire precautions should be installed by a competent person.

You must keep any equipment, devices or facilities that are provided at your site, event or venue for the safety of people, (e.g. fire alarms, fire extinguishers, lighting, signs, fire exits), in effective working order.

You must ensure that regular checks, periodic servicing and maintenance are carried out whatever the size of your site or venue and that any defects are put right as quickly as possible.

Checks should be undertaken before, during and after the event.

You, or a person you have nominated, can carry out certain checks and maintenance work. Further maintenance may need to be performed by a competent service engineer. Where contractors are used, third party certification is one method where a reasonable assurance of quality of work and competence can be achieved. (See Part 2, Section 8.)

The following are examples of checks and tests that should be considered. The examples of testing and maintenance given are not intended to be prescriptive and other testing regimes may be appropriate.

Daily checks (and/or checks before an event)

Remove any bolts, padlocks and security devices from fire exits (including perimeter fences) and check escape routes to ensure they are clear from obstructions. Check that all safety signs and notices are legible. Where practicable, check all emergency lighting units are in place and in working order. Check the provision of fire extinguishers and that they are present. Check the operation of communications systems such as public address system and radios. Check that staff, volunteers and stewards with designated responsibilities are available.

Weekly tests (and/or before an event)

Test fire-detection (where provided), fire warning systems, and manually-operated warning devices by following the manufacturers or installers instructions. Check the batteries of safety torches. Check that fire extinguishers and hose reels are correctly located and in apparent working order. Fire pumps and standby generators should be tested for 30 minutes each week.

Monthly tests (and/or before an event)

Test all emergency escape lighting systems and safety torches to make sure they have enough charge and illumination according to the manufacturers or suppliers instructions.

Monthly tests should be at an appropriate time when, following the test, they will not be immediately required, e.g. when no events are scheduled.

Six-monthly tests (and/or before an event)

A competent person should test and maintain the fire-detection and warning system and emergency escape lighting.

Annual tests and/or before an event)

The emergency escape lighting and all fire-fighting equipment, fire alarms and other installed systems should be tested and maintained by a competent person.

Where your event has only a short duration (e.g. 3 days) you may need to carry out all of the above plan checks to ensure that your site or event is adequately protected.

Appendix A provides an example of a fire safety maintenance checklist. You will find it of benefit to keep a log book of all maintenance and testing.

Further guidance on maintenance and testing on individual types of equipment and facilities can be found in the relevant section in Part 2.

Checklist

- Do you regularly check all escape routes and associated lighting and signs?
- Do you regularly check all your fire-fighting equipment?
- Do you regularly check your fire-detection and alarm equipment?
- Are those who test and maintain the equipment properly trained to do so?
- Do you have records of your testing?

Step 3 Checklist

- Have you considered the risk of fire starting?
- Have you evaluated the risk to people at your site or venue if a fire starts?
- Have you removed or reduced the hazards that might cause a fire?
- Have you removed or reduced sources of ignition?
- Have you removed or reduced sources of fuel?
- Have you removed or reduced sources of air or oxygen?
- Have you removed or reduced the risks to people if a fire occurs?
- Have you determined whether your escapes routes and exits are adequate?
- Do you have adequate signs and notices?
- Have you determined whether your emergency escape lighting is adequate?
- Have you considered the need for fire detection and for warning?
- Have you considered the need for fire-fighting equipment?
- Is the fire fighting equipment suitable for the purpose and in the right place?
- Have you considered whether you need any other equipment or facilities?
- Do you regularly test and maintain fire safety equipment?
- Have you considered how the emergency services will get to, in and around your site or venue?

STEP 4 RECORD, PLAN, INFORM, INSTRUCT AND TRAIN

In Step 4 there are four further elements of the risk assessment you should focus on to address the management of fire safety at your event or venue. At smaller sites this could be done as part of the day-to-day management. However, as the venue or the organisation grows it may be necessary for a formal structure and written policy to be developed. Further guidance on managing fire safety is given in Part 2 on page 43.

4.1 Record the significant findings and action taken

If you employ five or more people, your venue or event is licensed, or an alterations notice is in force, you must record the significant findings of your fire risk assessment and the actions you have taken.

Significant findings should include details of:

- the fire hazards you have identified (you don't need to include trivial things like a small tin of solvent-based glue);
- the actions you have taken, or will take, to remove or reduce the chance of a fire occurring (preventive measures);
- persons who may be at risk, particularly those especially at risk;
- the actions you have taken or will take to reduce the risk to people from the spread of fire and smoke (protective measures);
- the actions people need to take in case of fire, including details of any persons nominated to carry out a particular function (your emergency plan);
- the information, instruction and training you have identified that people need and how it will be given.

You may also wish to record discussions you have had with staff or staff representatives (including trade unions). Even where you are not required to record the significant findings, it is good practice to do so.

At small/simple sites or venues (e.g. village fete) record keeping may be no more than a few sheets of paper (possibly forming part of a health and safety folder), containing details of significant findings, any action taken and a copy of the emergency plan.

At larger/complex venues or events, it is best to keep a dedicated record including details of significant findings, any action taken, a copy of the emergency plan, maintenance of fire – protection equipment and training. There is no one 'correct' format specified for this.

It might be helpful to include a simple line drawing to illustrate your precautions (figure 9). This can also help you check your fire precautions as part of your ongoing review.

You must be able to satisfy the enforcing authority, if called upon to do so, that you have carried out a suitable and sufficient fire risk assessment. Keeping records will help you do this and will also form the basis of your subsequent reviews. If you keep records, you do not need to record all the details, only those that are significant and the action you have taken.

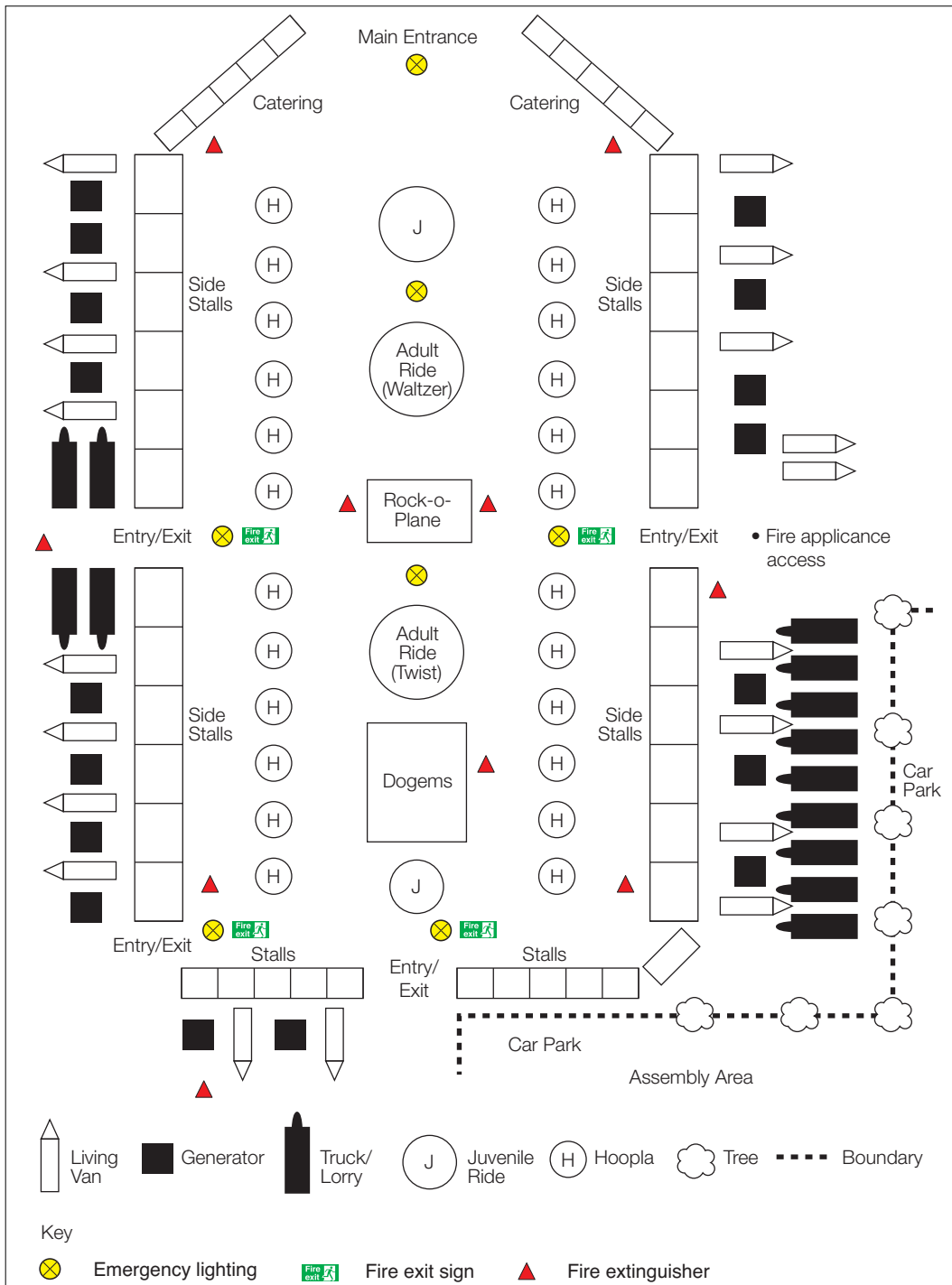

Figure 9: A site layout plan

The findings of your fire risk assessment will help you to develop your emergency plan, the instruction, information and training you need to provide, the co-operation and co-ordination arrangements you may need to have with other responsible people and the arrangements for maintenance and testing of the fire precautions. If you are required to record the significant findings of your risk assessment then these arrangements must also be recorded.

Further guidance about fire safety records with an example is given in Part 2, Section 7.1.

Checklist



- Have you recorded the significant findings of your assessment?
- Have you recorded what you have done to remove or reduce the risk?
- Are your records available for inspection by the enforcing authority?

4.2 Emergency Plan

You need to have an emergency plan for dealing with any fire situation. The purpose of an emergency plan is to ensure that the people on the site or venue know what to do if there is a fire and that the site can safely be evacuated allowing people to move to a place of safety.

If you or your organisation employ five or more people, or your event or venue are licensed or an alterations notice requiring it is in force, then details of your emergency plan must be recorded. Even if it is not required, it is good practice to keep a record.

Your emergency plan should be based on the outcome of your fire risk assessment and be available for your employees, their representatives (where appointed) and the enforcing authority.

At a small simple site the emergency plan may be no more than a fire action notice.

In multi-occupied, larger and more complex events or venues, the emergency plan will need to be more detailed and compiled only after consultation with other occupiers and other responsible people, e.g. owners who have control over the site and those in charge of various activities. In most cases this means that an emergency plan covering the whole site will be necessary. It will help if you can agree on one person to co-ordinate this task.

Provisions for events involving animals

Animals are liable to panic in fire and in view of this there should be additional safeguards to ensure that the public are able to use the means of escape to reach a place of total safety without being endangered by frightened animals.

You therefore need to ensure that the presence of animals does not increase the risk of fire occurring and that they are securely kept away from escape routes used by the public.

Your emergency plan may also need to take account of any obligations you may have in respect of the protection of any animals present in the premises.

Further guidance on emergency plans is given in Part 2, Section 7.2.

Checklist



- Do you have an emergency plan and, where necessary, have you recorded the details?
- Does your plan take account of other responsible people on the site?
- Is the plan readily available for staff, contractors, visitors, to read?
- Is the emergency plan available to the enforcing authority?

4.3 Inform, instruct, co-operate and co-ordinate

You must give clear and relevant information and appropriate instructions to your staff and the employers of other people working on your site, such as contractors, about how to prevent fires and what they should do if there is a fire.

If you intend to employ a child, you must inform the parents of the significant risks you have identified and the precautions you have taken. You must also co-operate and co-ordinate with other responsible people who use any part of the site or venue. It is unlikely that your emergency plan will work without this.

Information and instruction

All staff and volunteers should be given information and instruction as soon as they arrive on site and prior to starting work and regularly after that. Make sure you include people who work outside normal working hours, such as cleaners or maintenance staff.

The information and instructions you give must be in a form that can be used and understood. They should take account of those with a disability such as hearing or sight impairment, those with learning difficulties and those who do not use English as their first language.

The information and instruction you give should be based on your emergency plan and must include:

- the significant findings from your fire risk assessment;
- the measures that you have put in place to reduce the risk;
- what staff/volunteers should do if there is a fire;
- the identity of people you have nominated with responsibilities for fire safety; and
- any special arrangements for serious and imminent danger to persons from fire.

In a small/simple site or venue, where no significant risks have been identified and there are limited numbers of staff/volunteers, information and instruction may

simply involve an explanation of the fire procedures and how they are to be applied. This should include :

- showing staff/volunteers the fire-protection arrangements, including the designated escape routes;
- the location and operation of the fire-warning system;
- any other fire-safety equipment provided, such as fire extinguishers.

For a complex site or venue particularly those with multiple occupiers (e.g. a county show), you should ensure that written instructions are given to people who have been nominated to carry out a designated safety task, such as calling the fire and rescue service or checking that exit routes are available for use at the start of each working day.

Fire action notices can complement this information and where used, should be posted in prominent locations.

Further guidance on information and instruction to staff, and on working with dangerous substances is given in Part 2, Section 7.3.

Co-operation and co-ordination

At some venues you may be the responsible person. However, sites or venues owned by someone else, or where there is more than one occupier and others are responsible for different parts of the site (e.g. motor racing circuit), it is important that you liaise with them and inform them of any significant risks that you have identified. By liaising you can co-ordinate your resources to ensure that your actions and working practices do not place others at risk if there is a fire, and a co-ordinated emergency plan operates effectively.

Where two or more responsible persons share a site or venue the person with overall responsibility for the site or venue must co-ordinate any measures necessary to protect everyone from any risk that may arise. Employees also have a responsibility to co-operate with their employer so far as it is necessary to help the employer comply with any legal duty.

Further guidance on co-operation and co-ordination is given in Part 2, Section 7.3.

Checklist



- Have you told your staff about the emergency plan, including the identity of people you have nominated to perform a particular task?
- Have you given staff information about any dangerous substances?
- Do you have arrangements for informing temporary or agency staff?
- Do you have arrangements for informing other employers whose staff are guest workers on your site, such as maintenance contractors and cleaners?
- Have you co-ordinated your fire safety arrangements with other responsible people of the event?
- Have you recorded details of any information or instructions you have given and the details of any arrangements for co-operation and co-ordination with others?

4.4 Fire safety training

A key role is played by those responsible for keeping people safe at your site, event or venue. Your safety may include actions and responsibilities by people who are not members of your staff (e.g. volunteers). You must therefore provide adequate fire safety training for staff and other people with responsibilities at your event or venue.

The type of training should be based on the size, type, location and other features of your event or venue and should:

- take account of the findings of the fire risk assessment;
- explain your emergency procedures;
- take account of the work activity and explain the duties and responsibilities of staff (and others);
- take place during working hours and be repeated periodically where appropriate;
- address the roles of staff;
- where appropriate, be tested by fire drills; and
- be understandable by your staff and other people who may be present.

At simple sites this may be no more than showing staff/volunteers the fire exits and giving basic training on what to do if there is a fire. At sites or venues with a high staff turnover the organisation of fire safety training will need to be planned.

Your training should include the following:

- what to do on discovering a fire;
- how to raise the alarm;
- what to do upon hearing the fire alarm;
- the procedures for alerting members of the public and visitors including, where appropriate, directing them to exits;
- the arrangements for calling the fire and rescue service;
- the evacuation procedures for everyone to reach an assembly point at a place of total safety;
- the location and, when appropriate, the use of fire-fighting equipment;
- the location of escape routes, especially those not in regular use;
- where appropriate, how to stop machines and processes and isolate power supplies in the event of a fire;
- the safe use of, and risks from, storing or working with highly flammable and explosive substances; and
- the importance of general fire safety, which includes good housekeeping.

All people identified in your emergency plan that have a supervising role in a fire emergency should be given details of your fire risk assessment and receive appropriate training.

It is imperative that the person responsible for training is adequately trained to undertake the role of informing, training and instructing others.

Further guidance on fire safety training is given in Part 2, Section 7.4.

Checklist



- Have your staff/volunteers received any fire safety training?
- Have you carried out a practice evacuation recently (if practical)?
- Are people employees aware of specific tasks if there is a fire?
- Are you maintaining a record of training sessions?
- If you use or store hazardous or explosive substances, have your staff received appropriate training?

STEP 5 REVIEW

You should constantly monitor what you are doing to implement the fire risk assessment, to assess how effectively the risk is being controlled.

If you have any reason to suspect that your fire risk assessment is no longer valid or there has been a significant change in your site or venue that has affected your fire precautions, you will need to review your assessment and, if necessary, revise it. Reasons for this could include:

- significant changes to the event, for example a last-minute introduction of fairground attractions new acts, performances and activities;
- alterations to the degree of enclosure or reconfiguration of a site venue or exhibit, e.g. additional temporary structures/marquees.
- an increase in the number of, or changes to the type of people, or the presence of people with a disability;
- changes to the staffing structure;
- the introduction, change of use or increase in the storage of hazardous substances;
- failure of fire precautions, e.g. fire detection systems and warning systems;
- altering locations of exits or fixed/mobile seating;
- your past experience;
- incidents at other venues which did, or could have, injured people and from which lessons can be learned and preventative action taken.

You should consider the potential risk of any significant change before it is introduced. It is usually more effective to minimise a risk before introducing it to your site. During the event you should remain vigilant for any unplanned changes that introduce new hazards or increase the risk from an existing hazard.

Do not amend your assessment for every trivial change, but, if a change introduces new hazards you should consider them and, if significant, do whatever you need to do to keep the risks under control. In any case you should keep your assessment under review to make sure that the precautions are still working effectively. You may want to re-examine the fire prevention and protection measures at the same time as your health and safety assessment.

If a fire or 'near miss' occurs, this could indicate that your existing assessment may be inadequate and you should carry out a re-assessment. It is good practice to identify the cause of any incident and, then, review and/or revise your fire risk assessment in the light of this.

A post event review is good practice for events that occur periodically to help ensure that fire safety arrangements are relevant to and appropriate for the next event or to the changing needs of your venue and its visitors. The review will help to identify areas where changes are needed and/or introduce suggested improvements. Review your event as soon as possible after it has finished, in order to ensure that any problems are still relatively fresh in people's memories. If many of the staff are likely to disperse, you may wish to carry out a rapid debriefing as soon as practicable and use the report of this in the full review. In general, representatives of all parties involved in the event should take part in the review. Where possible, select representatives who can give you the fullest picture of all aspects of the event. Specific training for your own staff involved in the review process can help to improve its effectiveness.

5.1 Alterations notices

If you have been served with an 'alterations notice' check it to see whether you need to notify the enforcing authority about any changes you propose to make as a result of your review. If these changes include building work, you should also consult the building control body.

END OF PART 1

You should now have completed the five-step fire risk assessment process, using the additional information in Part 2 where necessary. In any review you may need to revisit Steps 1 to 4.

Part 2 Further guidance on fire risk assessment and fire precautions

Managing fire safety

Good management of fire safety will help to ensure that any fire safety matters that arise are always effectively addressed. At small venues or events this can be achieved by the manager or owner planning and maintaining fire safety in conjunction with general health and safety.

At larger events or venues it is good practice for a senior manager to have overall responsibility for fire safety. It may be appropriate for this responsibility to be placed with the manager designated with overall responsibility for health and safety.

An organisation's safety policy should incorporate fire safety and should be flexible enough to allow modification. The policy should be set out in writing and may cover such things as:

- who will hold the responsibility for fire safety at the most senior level;
- who will be the responsible person for each part of the site (this will be the person who has overall control, usually the manager, but may be part-time or shift managers);
- the arrangement whereby managers will, where necessary, nominate in writing specific people to carry out particular tasks if there is a fire;
- the arrangement whereby the overall responsible person should monitor and check that individual managers are meeting the requirements of fire safety law.

You should have a plan of action to bring together all the features you have evaluated and noted from your fire risk assessment so that you can logically plan what needs to be done. It should not be confused with the emergency plan, which is a statement of what you will do if there is a fire.

The plan of action should include what you intend to do to reduce the hazards and risks you have identified and to implement the necessary protection measures.

You will need to prioritise these actions to ensure that any findings which identify people in immediate danger are dealt with straight away. In other cases, at permanent outdoor sites or venues, where people are not in immediate danger but action is still necessary, it may be acceptable to plan this over a period of time.

You or a designated responsible person should be in charge of and be present on the site during the whole time the site is open to the public and kept free from work, which would prevent the individual from being available immediately in the event of an alarm of fire.

You need to be aware that certain events e.g. music festivals, can present additional dangers for the audience, largely from the effects of over excitement and irrational behaviour as well as the noise level and flashing lights. In such circumstances, and particularly where there is a mainly younger audience, you should ensure that there are a sufficient number of competent and adequately trained stewards to cover an emergency situation.

Before admitting the public to your site you need to ensure that all of your fire safety provisions are in place and in working order, or, if not, that alternative arrangements are in place. Constant checks are needed while the public are present, and again after they have left. Detailed recommendations are given in British Standard Fire Precautions in the design, construction and use of buildings – Part 12: Managing fire safety, BS5588-12:2004³⁹, The Event Safety Guide¹⁰ and The Guide to Safety at Sports Grounds¹¹.

The guidance in Part 2 provides additional information to:

- ensure good fire safety management by helping you establish your fire prevention measures, fire precautions and fire safety procedures (systems equipment and plans); and
- assist you to carry out your fire safety risk assessment and identify any issues that need attention.

Section 1 Further guidance on fire risks and preventative measures

This section provides further information on evaluating the risk of a fire and its prevention at your event or venue. You should spend time developing long-term workable and effective strategies to reduce hazards and the risk of a fire starting. At its simplest this means separating flammable materials from ignition sources.

You should consider:

- housekeeping;
- storage;
- dangerous substances; storage, display and use;
- equipment and machinery;
- electrical safety;
- smoking;
- managing construction, assembly and alterations;
- restricting the spread of fire and smoke;
- arson;
- vehicles; and
- help for people with special needs.

1.1 Housekeeping

For most sites, good housekeeping will lower the chance of a fire starting, so the accumulation of combustible materials should be monitored carefully.

Keep waste material in suitable containers before it is removed from the site. If bins, particularly wheeled bins, are used, secure them in a compound to prevent them being moved to a position next to an enclosure and set on fire. Never place skips near an enclosure (tent or vehicle, see Figure 10) – they should normally be a minimum of 6 m away from any structure on the site.

If you generate a considerable quantity of combustible waste material then you may need to develop a formal plan to manage this effectively.

Good housekeeping reduces the chances of escape routes being blocked or obstructed or potentially hazardous source of fuel from developing. The level of responsibility of an event organiser and concessionaire with regards to housekeeping must be defined.

All parts of the site or venue should be inspected before, during and after each event or period open to the public and any accumulation of waste or litter should be removed without delay.

Combustible waste and packaging

Some events involve large quantities of combustible waste and packaging, which may have been used to protect goods or exhibits in transit. The sighting, use and removal of these materials needs to be carefully managed to ensure that they can not come into contact with potential ignition sources, and do not cause obstructions.

Figure 10: Example of poor housekeeping at open air events

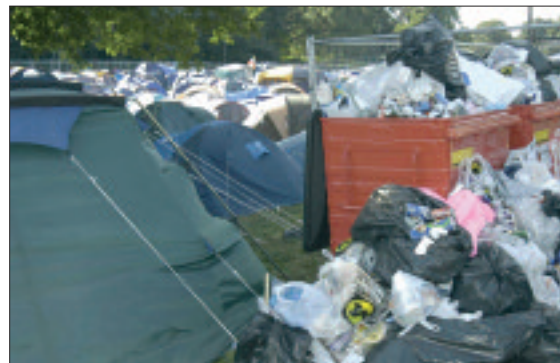

1.2 Storage

Many of the materials found at your event or venue will be combustible. If you have inadequate or poorly managed storage areas then the risk of fire is likely to be increased.

At outdoor events and venues great care will often be taken to present an efficient and attractive image in the public areas, while storage areas are neglected and allowed to become dumping areas for unused material.

Combustible materials are not just those generally regarded as highly combustible, such as polystyrene, but all materials that will readily catch fire e.g. displays or artificial flowers. Even non-combustible materials may present a fire hazard when packed in combustible materials. However, by carefully considering the type of material, the quantities kept and the storage arrangements, the risks can be significantly reduced.

Stacks of combustible materials (e.g. food stuffs, packaging), can increase the fire hazard. Such readily available combustible materials makes the potential effect of arson more serious.

To reduce the risk, store excess materials in a dedicated storage area. Do not store excess materials in areas where the public would normally have access.

As well as considering the materials used at your site or event you should also consider their form. For example, wood in solid baulks of timber is not readily ignitable, but chopped wood or kindling is. Cardboard stored flat would not present a high fire risk, but rolls of cardboard stored vertically present a vertical surface for fire to spread rapidly upwards; corrugated cardboard presents an even greater risk.

The fire risk assessment should also consider any additional risk generated by seasonal products such as Christmas decorations and by products such as fireworks.

Consider the following to reduce these risks:

- Ensure you have sufficient suitable storage areas for your needs;
- ensure storage areas are adequately controlled and monitored;
- use fire-resisting display materials wherever possible (suppliers should be able to provide evidence of this); and
- ensure electrical lighting used as part of the display does not become a potential source of ignition.

Outdoor storage

The main risks associated with outdoor storage are outdoor fires spreading to the buildings, structures or enclosures. Fires are most likely to start in waste material or dry undergrowth. Tarpaulin, jute and plastic sacks can readily burn too.

Sparks, cigarettes and arson are the likely ignition sources. To reduce these risks, ensure that:

- goods, materials, pallets and vehicles are sited in designated storage areas away from a temporary building, stage area or arena fire exits, boundary fences; and
- outdoor areas are kept tidy, by clearing waste and vegetation.

1.3 Dangerous substances; storage, display and use

Specific precautions are required when handling and storing dangerous substances to minimise the possibility of an incident. Your supplier should be able to provide detailed advice on safe storage and handling, however, the following principles will help you reduce the risk from fire:

- substitute highly flammable substances and materials with less flammable ones;
- reduce the quantity of dangerous substances to the smallest reasonable amount necessary for running the business or organisation;
- correctly store dangerous substances, e.g. in a fire-resisting enclosure. All flammable liquids, and gases substances should ideally be locked away, especially when the events or venues are unoccupied, to reduce the chance of them being used in an arson attack. This may include storage of materials such as fireworks or pyrotechnics; and
- ensure that you and your employees are aware of the fire risk the dangerous substances present and the precautions necessary to avoid danger.

Additional general fire precautions may be needed to take account of the additional risks that may be posed by the storage and use of these substances.

Certain substances and materials are by their nature, highly flammable, oxidising or potentially explosive. These substances are controlled by other legislation in addition to fire safety law, in particular the Dangerous Substances and Explosive Atmospheres Regulations 2002¹³ (also see HSE's *Approved Code of Practice and guidance*¹⁴).

Flammable Liquids

Highly flammable liquids present a particularly high fire risk. For example, a leak from a container of flammable fuel, such as petrol, may produce large quantities of heavier-than-air flammable vapours. These can travel large distances, increasing the likelihood of their reaching a source of ignition well away from the original leak, such as a catering facility or equipment on automatic timers.

Flammable liquids stored in plastic containers can be a particular problem if involved in fire because they readily melt spilling their contents and fuelling rapid fire growth.

The risk is reduced by ensuring the storage and use of highly flammable liquids is carefully managed, that materials contaminated with solvent are properly disposed of and when not in use, they are safely stored. Up to 50 litres may be stored in a fire-resisting cabinet or bin that will contain any leaks. (See Figure 11.)

Quantities greater than 50 litres should be stored in a dedicated highly flammable liquids store. Further guidance on the storage of highly flammable liquids in containers is available from the HSE.

Figure 11: A 50 litre storage bin for flammables

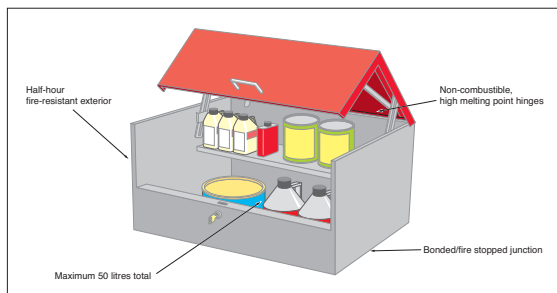

There should be no potential ignition sources in areas where flammable liquids are used or stored and flammable concentrations of vapours may be present. Any electrical equipment used in these areas, including emergency escape lighting systems, needs to be suitable for use in flammable atmospheres. In such situations, you should seek advice from a competent person.

LPG use, storage and disposal

Where LPG in cylinders or cartridges is present, you need to take particular care to minimise the possibility of their involvement in a fire. The total stock of LPG should be kept to the minimum necessary to meet your needs.

Locate the LPG cylinders and cartridges in a safe secure and well ventilated place, where they cannot be interfered with, can be kept upright (with valve protection fitted), are away from sources of ignition and /or readily ignitable materials, and are away from any corrosive toxic or oxidant materials. (See figure 12.)

Further guidance on the safe storage of LPG is available from your supplier or the Liquefied Petroleum Gas Association's Code of Practice.¹⁵

Figure 12: Example of poor storage – LPG cylinders with other combustibles



Piping

Piping conveying gas or flammable liquid should be as far as practicable, of rigid material.

Any necessary piping should consist of material suitable for the gas or liquid being conveyed, adequately reinforced to resist crushing and withstand the maximum internal pressure to which it may be subjected. Any connections to the flexible piping should be of an approved pattern (i.e. screwed or otherwise secured to prevent accidental disconnection).

If in doubt you should seek advice from a competent person.

Storage and use of cylinders

Only those compressed gas cylinders or gas vessels containing flammable liquids or gas under pressure required for immediate use should be kept within the premises. Any spare cylinders should be stored in a safe and secure location outside the building.

Hazardous materials

Where it is necessary to use hazardous materials, such as fuels (whether in containers or within fuel tanks and machinery), fertilisers, weed killers, paints or gas cylinders used for medical purposes, they should be stored in a

secure and safe location, for example a properly ventilated fire-resistant storeroom. Care should also be taken to ensure that incompatible materials are not stored together. If in any doubt you should seek the advice of your supplier.

Fireworks and explosives

Pyrotechnics are used in many productions from a small show to major rock concerts and the dangers inherent in the types used for the entertainment industry should be understood.

Fireworks, pyrotechnics and explosives can cause fires and explosions. They have the potential for a violent release of pressure and heat that can cause severe harm to people and damage to structures. These materials can be ignited or detonated by contact with ignition sources or by contamination, where other chemicals or water cause the material to become unstable.

Preventative measures include:

- excluding ignition sources;
- appropriate storage containers;
- training in the handling of fireworks and explosives; and
- establishing separation distances between buildings containing explosives.

One of the most common problems with the use of pyrotechnics is lack of pre-planning. Pyrotechnics are often required but decisions are made very late with the result of trying to incorporate them into a show after everything else. With early planning many of the problems can be overcome and unnecessary risks reduced.

Particular care should be taken with certain types of pyrotechnics that produce:

- sparks / fall-out which can remain hot for some time even after returning to ground level (e.g. star effects, gerbs, stage mines, saxons, airbursts);
- fall-out over a wide area (e.g. waterfall effect, saxons, airbursts);
- considerable heat (e.g. coloured fire);
- considerable amount of smoke (e.g. smoke puffs, coloured smoke, waterfall effect);
- naked flame (e.g. flame effects).

You should adopt and enforce a clear policy prohibiting people from bringing flares or fireworks into the event or venue.

The primary control on the supply and acquisition of fireworks are the Fireworks Regulations 2004 (as amended²²). The minimum age for the acquisition of fireworks is 18 years.

The Explosives Act 1875²³, as modified by the Control of Explosives Regulations 1991²⁴ requires that explosives are kept in a legal place of keeping. For further information contact the local authority or HSE.

Smoke and vapour effects

Smoke/vapour outlets should not be sited where their output can be discharged or drift into exits, exit routes, stairways, means of escape routes. Actual operation of the machine should take account of public safety and should be limited to the minimum amount of time required to achieve the necessary level of density.

Fans should be used, where necessary, to direct the smoke/vapour into the desired area, in order to prevent clouding at the point of discharge and possible overspill into other parts of the event or venue. Before the use of a smoke or vapour effect is approved consideration should be given to any automatic fire detection or fire sensor system installed in the premises.

Such equipment should be operated safely and in accordance with manufacturer's instructions. However, such devices can create an illusion of the presence of fire (and/or smoke) and consequently some additional measures may need to be taken to avoid unnecessary alarm and also to ensure that the use of such devices does not disguise the presence of a real fire.

Detailed recommendations on the use and storage of explosives and flammable substances are given in the HSE Entertainment Sheet No. 3⁶, Association of British Theatre Technicians Code of Practice²⁷ and HSG 195 – The Event Safety Guide¹⁰. For Firework displays refer to HSG 123 'Working together on fireworks displays'²⁵.

1.4 Equipment and machinery

Common causes of fire in equipment are:

- allowing ventilation points to become clogged or blocked, causing overheating;
- Inadequate cleaning of equipment, such as fryers.

- allowing extraction equipment in catering environments to build up excessive grease deposits;
- misuse or lack of maintenance of cooking equipment and appliances;
- overheating cooking equipment such as deep fat fryers;
- disabling or interfering with automatic or manual safety features and cut-outs;
- leaking valves, glands or joints allowing oils and other flammable liquids to contaminate adjacent goods;
- loose drive belts or lack of lubrication leading to increased friction;
- refuelling without interrupting operation (particularly petrol generators); or
- overheating electrical extension reels because they have not been unwound.

All machinery, equipment and plant should be properly maintained by a competent person. Appropriate signs and instructions on safe use may be necessary.

Heating

Individual heating appliances require particular care if they are to be used safely. The greatest risks arise from lack of maintenance and unfamiliarity. Heaters should be secured in position on hard standing when in use and fitted with a fireguard if appropriate.

The following rules should be observed:

- all heaters should be kept well clear of combustible materials and placed where they do not cause an obstruction, particularly to escape routes.
- portable fuel burning heaters (including LPG) should only be used in public areas in exceptional circumstances and if shown to be acceptable in your risk assessment, and
- unless specifically designed for use in the open air such heaters should be sited away from draughts.

All gas heating appliances should be used only in accordance with manufacturer's instructions and should be serviced annually by a competent person. You should check that all such equipment to be used on your site is provided with a maintenance record.

Cooking processes

Catering facilities at open air events are based on equipment that is designed to be highly mobile. They may be fixed within a vehicle or placed within a tent, marquee or other similar temporary structure. Typical installations used in cooking processes include: deep fat fryers, surface fryers, ovens, grills and surface cookers, with flues, filters, hoods, extract and, in some cases, ventilation ducts. These cooking processes can operate at high temperatures, involve large quantities of oil and combustible foodstuffs. Heat sources used for cooking processes are mainly LP gas but also include electricity.

The main causes of fire are ignition of cooking oil, combustion of crumbs and sediment deposits, and, where fitted, duct work fires from a build up of fat and grease. The siting of cooking processes close to combustible materials can lead to rapid fire growth and spread to other parts of the site. This practice should therefore be avoided where possible.

The following should be considered, as appropriate to the size and location of the installation, to reduce the fire risk from cooking processes:

- regular cleaning to prevent build-up of crumbs and other combustible material;
- fire resisting containers for waste product;
- a fire suppression system capable of controlling an outbreak of fire (these could be fitted within a mobile catering vehicle);
- monitored heat/oil levels, even after the cooking process is complete, and installation of temperature control/cut-off/ shut-off devices as appropriate;
- duct, joints and supports able to withstand high cooking temperatures;
- insulation of ducts to prevent heating/igniting nearby combustible materials and wall/ceiling panels;
- a regular programme for inspection and cleaning;
- a programme of electrical and mechanical maintenance; and
- annual service of all gas heating appliances by a competent person.

Figure 13: Mobile deep fat fryers too close to combustibles



1.5 Electrical safety

Electrical equipment is a significant cause of accidental fires. The main causes are:

- overheating cables and equipment, e.g. due to overloading circuits, bunched or coiled cables or impaired cooling fans;
- incorrect installation or use of equipment;
- lack of maintenance or testing;
- damaged or inadequate insulation on cables or wiring;
- combustible materials being placed too close to electrical equipment, which may give off heat even when operating normally, or may become hot due to a fault;
- arcing or sparking by electrical equipment;
- embrittlement and cracking of cable sheathing in cold environments;
- bunched cables passing through insulation which can generate excessive heat; and
- impaired cooling fans.

All electrical equipment should be installed and maintained in a safe manner by a competent person. If portable electrical equipment is used, then your fire risk assessment should ensure that it is visually inspected and undergoes portable appliance testing ('PAT') at suitable intervals (refer to HSE guidance HSG 107¹⁶). If you have any doubt about the safety of your electrical installation then you should consult a competent electrician.

Issues to consider include:

- insulation earthing and electrical isolation requirements;
- cable routing and fixing;
- correct fuse ratings;
- PAT testing and testing of the fixed installation;
- protection against overloading of installation;
- use of residual current devices (RCDs)
- protection against short circuit;
- frequency of electrical inspection;
- temperature rating and mechanical strength of flexible cables;
- portable electrical equipment, including lanterns;
- physical environment in which the equipment is used (e.g. wet or dusty atmospheres);
- use and maintenance of suitable personal protective equipment; and
- voltage of the electrical equipment, (e.g. 110v or lower).

All lamps, lanterns, lighting appliances and any other apparatus liable to become heated whether under normal or abnormal conditions and liable to come into contact with combustible materials may need to be fitted with suitable guards. Such guards should be of wire mesh or of such other type as will afford ventilation, should be rigidly fixed and, where practicable, should be at a distance of at least 300mm vertically above and 75mm horizontally from the casing of the lamp or holder.

All electrical installations should be regularly maintained by a competent person, appointed by you, or on your behalf, in accordance with the Electricity at Work Regulations 1989²⁸ (EAW Regulations). The use of low voltage equipment should conform to the requirements of the Electrical Equipment (Safety) Regulations 1994²⁹, including the requirement to be CE marked.

For further guidance refer to the HSG 195.¹⁰

1.6 Smoking

Carelessly discarded cigarette and other smoking materials are a major cause of fire. You may consider prohibiting smoking at your event or venue but at an open air site this may be impractical or impossible to enforce. If you consider that a part of your event is susceptible to the risks from unauthorised smoking you should put appropriate measures in place to prevent fires.

Prohibition of smoking in marquees or temporary buildings is likely to be more practical to achieve. In those enclosed areas where smoking is permitted, provide deep and substantial ashtrays to help prevent unsuitable containers being used. Empty all ashtrays regularly into a metal waste bin and take it to a suitable disposal area outside. It is dangerous to empty ashtrays into plastic waste sacks, which are then left for disposal later. Keep the area clear of combustibles and maintain any furniture in good repair.

Also consider the ground upon which smokers are standing and ensure that discarded smoking materials will not start grass or other similar fires in vegetation.

1.7 Managing building work and alterations

Many outdoor events and venues (particularly permanent sites) will include buildings and other structures (temporary/permanent). You should ensure that, before any work starts on the creation of your event or the alteration of an existing attraction, that you have evaluated the fire risks or reviewed the fire risk assessment, as appropriate, and considered what dangers are likely to be introduced. You will need to evaluate the risks to people, particularly in those areas that continue to be occupied while alterations take place. Lack of pre-planning can lead to haphazard co-ordination of fire safety measures.

You should liaise and exchange information with contractors who will also have a duty under the Construction (Health, Safety and Welfare) Regulations 1996^{17,18} to carry out a risk assessment and inform you of their significant findings and the preventative measures they may employ. This may be supported by the contractors' agreed work method statement. The designer should also have considered fire

safety as part of the Construction (Design and Management) Regulations 1994 (The CDM Regulations)⁷¹.

You should continuously monitor the impact of any changes on the general fire safety precautions, such as the increased risk from quantities of combustible materials and accumulated waste. You should only allow the minimum materials necessary for the work in hand within or adjacent to your event or venue.

Activities such as welding, flame cutting, use of blow lamps or portable grinding equipment can pose a serious fire hazard and need to be strictly controlled when carried out in areas near flammable materials. This can be done by having a written permit to work for the people involved (whether they are your employees or those of the contractor).

A permit to work is appropriate in situations of high hazard/risk and, for example, where there is a need to:

- ensure that there is a formal check confirming that a safe system of work is being followed;
- co-ordinate with other people or activities;
- provide time-limits on when it is safe to carry out the work; and
- provide specialised personal protective equipment or methods of communication.

Additional risks during construction work include:

- hot work including paint stripping;
- temporary electrical equipment;
- blocking of escape routes;
- loss of normal storage facilities;
- fire safety equipment, such as automatic fire detection systems being affected; and
- additional personnel who may be unfamiliar with the event or venue.

You must notify the Fire and Rescue Service about alterations in your premises if an Alterations notice is in force.

Further guidance on fire safety during construction work is given by the HSE^{18, 19, 73, 74}) and the Fire Protection Association.⁷⁵)

1.8 Restricting the spread of fire and smoke

To reduce the risk to people if there is a fire, you need to consider how to control or restrict the spread of fire and smoke.

Catering facilities

Wherever possible any extensive all catering facilities, particularly these with deep fat fryers, should be located in areas dedicated to catering. If located within or adjacent to other activities or structures they should be separated from those activities or structures by either a suitable distance or by fire resisting construction and provided with adequate ventilation. Where flues pass through any part of the structure, (e.g. temporary building) the structure should be protected by fire-resisting construction and the flue should terminate at a point where emissions can disperse in the open air.

In permanent buildings where fire shutters are used to separate the risk from other areas these should be capable of operating both manually and by fusible link. Where a fire detection and warning system is installed, the fire shutter should also be designed to close on the activation of the system.

Decorations and display materials

You should evaluate what material could ignite first and what would cause the fire to develop and spread, and assess how materials used in displays would interact with surface linings or the fabric of any enclosure and position them accordingly. In particular, displays such as paper, textiles or other flimsy materials should not be located in escape routes or adjacent to exits. However, such materials may be acceptable in other locations if treated with an appropriate fire-retardant product.

Fire-resisting structures

There may be limited instances at your site event or venue where temporary buildings are divided into different areas by fire doors and walls. These may be designed to keep a fire within one area, giving people more time to escape. You will need to identify which doors and walls are fire resisting.

Normally if there are fire doors in a wall, then the wall itself will also need to be fire resisting (see Appendix C1 for more technical information about fire – resisting walls and doors). If a wall is required to be fire-resisting then you should not make any holes in it, e.g. for extra doors or pipe ducts, without consulting a competent person.

To ensure effective protection against fire any openings such as doors, ventilation ducts, or pipe passages providing fire separation must form a complete fire-resisting barrier.

The passing of services such as heating pipes or electrical cables through fire-resisting walls or partitions may leave gaps through which fire and smoke may spread. These should be rectified by suitable fire stopping and there are many proprietary products available for this purpose to suit particular types of construction.

Tents and Marquees

Marquees and large tents are prominent in open-air events. The following information is provided to assist you to manage the fire risk.

Modern fabric materials are generally fire retardant. However, special criteria may apply to tents or marquees, particularly where high occupancy levels are expected. All fabric should meet an appropriate fire performance. Further guidance can be found in BS 7837³¹.

Materials which are durably or non-durably flame-retarded may be adversely affected by weathering, so fabric which has achieved the required level of flame retardancy by chemical treatment will need to be periodically retreated. If the tent or marquee is in constant use throughout the summer season (e.g. from April to October), such retreating should be carried out when the fabric is showing signs of obvious wear or ageing or not later than 5 years after the date the panel was made up. Thereafter, testing should be at two-yearly intervals. Such test results should be suitably certificated.

Some marquees and large framed tents comprise a complete single unit and are used only occasionally (three or four times a year). Such marquees should have supporting documentation including test certificates which confirm their composition and standard flame retardancy, together with diagrams and/or photographs of the structure. When they are used, a record should be kept of each event and retesting will only need to be carried out when the fabric shows signs of wear or ageing. All new structures should have an accompanying log book from the date of manufacture.

Linings for marquees and large tents may be suspended using ropes constructed from manmade or natural fibres and may be laced together using the same materials. Linings should only be used if constructed from an

appropriately and preferably inherently flame-retardant material. If materials requiring flame-retardancy pre-treatment are used, e.g. cotton or wool, this process should be carried out according to manufactures instructions and a record kept accordingly.

Some floor coverings may react in fire to produce large amounts of heat and smoke, although the rate of surface spread of flame may be relatively slow. The environment may also have a significant effect on the burning behaviour of materials, as wind can cause a fire to spread more rapidly. It can also blow smoke into escape routes and so adversely affect the means of escape. A similar situation may occur where a lack of adequate ventilation causes smoke to be concentrated in a particular area. Floor coverings may be re-usable or disposable and should have low flame spread characteristics.

For further information about tents and marquees contact The Performance Textiles Association (PTA); and/or consult chapter 12 of the Institution of Structural Engineers document, Temporary demountable structures³⁰ and/or the Event Safety Guide.¹⁰

Air supported structures

An Air supported structure is a structure that has a space-enclosing single skin membrane anchored to the ground and kept in tension by internal air pressure so that it can support applied loading. The membrane may or may not be restrained by trans-surface ropes or cables.

Guidance on the materials used in the construction of pneumatic structures can be found in BS6661.³²

Pneumatic structures

A risk peculiar to pneumatic structures is that their stability is dependent upon a supply of air under pressure, which is provided and maintained by mechanical fans. Additionally such structures comprise extensive areas of flexible membrane material, which, like those used for tents, requires particular care in selection.

For these reasons, safety measures peculiar to pneumatic structures include reliability of air supply systems supplemented by secondary support systems to maintain clear exit routes in case of collapse together with the selection of suitable (flame-retarded) membrane materials.

The membrane of an air supported structure should not readily support combustion. Experience has shown that PVC coated polyesters and polyamides and unreinforced polythene generally perform satisfactorily under fire conditions. A small number of fire tests on air supported structures of various sizes have shown that if the flames in a fire reach and damage the membranes at a high level (above 2.5m), the internal pressure will be reduced and, depending on the size of the hole, the fan capacity and the number of doors opened, the structure may collapse.

Combustible contents

Most enclosures (marquees, temporary building etc.) at your event or venue will contain a range of combustible contents. All materials used in finishing and furnishing should, as far as reasonably practicable, be difficult to ignite and provide a low surface spread of flame and low rates of heat release and smoke emission. Combustible contents are likely to include:

- furnishings, upholstered seating, furniture and cushions;
- curtains, drapes and other textile hangings;
- artificial and dried foliage;
- decorative textile fabrics (e.g. within stands);
- sports and play area furnishings, such as cellular foam gym mats; and
- scenery or properties used for stage presentations.

The use of furnishings and other materials which are easily ignited or have rapid spread of flame characteristics should be avoided.

All fabrics, curtains, drapes and similar features should either be non-combustible or be of durably or inherently flame retardant fabric.

Upholstered seating, carpets and other textile floor coverings should be resistant to ignition.

Foam for props and similar equipment should ideally contain only combustion modified high resilience foam.

Scenery used for stage presentations often comprise combustible materials, so you need to take particular care with their use. In particular, when they are on an open stage area within an enclosure, when you should seek to use only materials which you know are not combustible.

Ad-hoc flame tests

Ad-hoc flame tests can be used on a small sample to screen out some materials. Simple match tests, or using a cigarette lighter on a small sample, can be used to assess ease of ignition, provided that the test is carried out in the open air, away from combustible materials and with a fire extinguisher to hand.

1.9 Arson

Arson at open air events is not a recorded statistic. However, recent studies indicate that, across all other premises types, over 2,100 deliberately set fires, resulting in two deaths, and 55 injuries occur every week. All premises can be targeted either deliberately or just because they offer easy access.

Fires started deliberately can be particularly dangerous because they generally develop much faster and may be started in escape routes or other sensitive locations. Of all the risk-reduction measures, the most benefit may come from efforts to reduce the threat from arson.

Be aware of small, deliberately set fires in the locality, which may indicate an increased risk to your site, event or venue. Be suspicious of any small 'accidental' fires and investigate them fully.

Measures to reduce arson may include the following:

- ensure that the site is well lit and, if practical, secure the perimeter of the event or venue;
- but make sure that any people working late or alone still have adequate escape routes;
- do not place rubbish skips adjacent to occupied areas and secure waste bins in a compound separated from occupied areas;
- make sure you regularly remove all combustible rubbish;
- do not place vehicles, caravans or other portable structures adjacent to occupied areas;
- encourage staff to challenge people acting suspiciously;
- secure flammable liquids so that intruders cannot use them;

- remove automatic entry rights from staff who have been dismissed; and
- ensure that your security, alarm/fire-detection system is monitored and acted on.

Further guidance on the reducing the risk of arson has been published by the Arson Prevention Bureau.*

1.10 Vehicles

During dry conditions additional precautions may be necessary, to prevent the spread of fire to permanent or temporary structures through the ignition of vegetation by vehicles, e.g. ensure vegetation is 'maintained' in order to reduce the probability of contact with any vehicles and care taken not to use stubble fields.

Whenever possible vehicle parking should be separate from the event. Vehicle movements must be controlled before, during and after the event. Catering operations located within vehicles and trailers present additional risks and should be assessed in detail. Further guidance on the measures to be taken can be found in *The Event Safety Guide*¹⁰.

1.11 Help for people with special needs

Of all the people who may be especially at risk you will need to pay particular attention to people who have special needs including those with a disability. The Disability Rights Commission estimates that 11 million people in this country have some form of disability, which may mean that they find it more difficult to leave an event or venue if there is a fire. Under *The Disability Discrimination Act*,³⁷ if disabled people could realistically expect to use the service (or premises) you provide, then you must anticipate any provisions that would make it easier for that right to be exercised.

*The Disability Discrimination Act*³⁷ includes the concept of 'reasonable' provisions and this can be carried over into fire safety law. It can mean different things in different circumstances. For a small event it may be considered reasonable to provide ramps to assist wheelchair users. However, it might be unreasonable to expect that same event to install an expensive public

*Visit www.arsonpreventionbureau.org.uk for more information.

address system. Appropriate 'reasonable' provisions for a large event or venue or organisation may be much more significant.

If disabled people are going to be at your event or venue then you must also provide a safe means for them to leave if there is a fire. You and your staff should be aware that disabled people may not react, or can react differently, to a fire warning or a fire. You should give similar consideration to others with special needs such as parents with young children or the elderly.

At sites with a simple layout, a common sense approach, such as offering to help lead a blind person or helping an elderly person across rough terrain may be enough. At more complex events, more elaborate plans and procedures will be needed, with trained staff assigned to specified duties. At a complex event, you may also wish to contact a professional consultant or take advice from disability organisations.

Consider the needs of people with mental disabilities or spatial recognition problems. The range of disabilities encountered can be considerable, extending from mild epilepsy to complete disorientation in an emergency situation. Many of these can be addressed by properly trained staff, discreet and empathetic use of the 'buddy system' or by careful planning of colour and texture to identify escape routes.

Where people with special needs use or work at an event or venue, their needs should, so far as is practicable be discussed with them. These will often be modest and may require only changes or modifications to proposed or existing procedures.

As part of your consultation exercise you will need to consider the matter of personal dignity. If members of the public use your event or venue then you may need to develop a range of standard Personal Emergency Evacuation Plans (PEEPs) which can be provided on request to a disabled person or others with special needs. You should also consider the particular needs of children and the elderly who may be using your premises. Additional attendants or staff may be needed. Similarly, special consideration may be needed if members of the public are likely to be intoxicated.

Guidance on removing barriers to the everyday needs of disabled people is in BS 8300³⁸. Much of this advice will also help disabled people during an evacuation. Further advice can be obtained from the Disability Rights Commission at www.drc-gb.org.

Section 2 Further guidance on fire detection and warning systems

The primary purpose of a fire detection and warning system is to alert people to enable them to move away from a fire to a place of total safety while the escape routes are still clear of smoke.

Fire detection and warning at open-air events and similar venues needs to be considered for both open air and inside locations and should include:

- how fire will be detected;
- the means for warning people and the actions you require people to take.

Open air fires will generally be detected by the people present so the primary consideration is the means of fire warning. Where shouted warnings are insufficient to direct people, then alternative provisions such as a P.A. system should be considered.

For inside areas where a simple shouted warning or manual device such as a gong, whistle or horn, is insufficient to warn everyone when operated from a single point, it is likely that an electrical fire warning system may be required. This will typically include the following:

- manual call points (break-glass call points); next to exits with at least one call point on each floor;
- electronic sirens, bells or a public address facility; and
- a control and indicator panel.

If your event or venue has areas where a fire could develop undetected or where people work alone and might not see a fire, then it may be necessary to upgrade your fire-warning system to incorporate automatic fire detection.

If, for any reason, your system fails you must still ensure that people at your event or venue can be warned and escape safely. A temporary arrangement, such as whistles or air horns, combined with suitably trained staff located in key positions (to ensure the whole site is

covered), may be acceptable for a short period, pending system repairs.

The fire warning sound levels should be loud enough to alert everyone, taking into account background noise. Any sound systems should be muted (automatically or manually) when the fire alarm sounds. In areas with uncontrollable high background noise, or where people may be wearing hearing protectors (such as plant rooms, music concert), the audible warning should be supplemented e.g. with visual alarms.

People with Hearing Difficulties

Where people have hearing difficulties, particularly those who are profoundly deaf, then simply hearing the fire warning is likely to be the major difficulty. If these persons are never alone while on the site then this may not be a serious problem, as it would be reasonable for other people to let them know that they should evacuate. If a person with hearing difficulties is likely to be alone, then consider other means of raising the alarm, e.g. visual beacons and vibrating pagers linked to the existing fire alarm.

2.1 Manual Call Points

Manual call points, often known as 'break-glass' call points, enable a person who discovers a fire to immediately raise the alarm and warn other people of the danger.

People leaving a temporary building because of fire will normally leave by the way they entered. Consequently, manual call points are positioned at exits that people may reasonably be expected to use in case of fire, not just those designated as fire exits. However, it is not necessary in every case to provide call points at every exit.

Manual call points should normally be positioned so that, after all fixtures and fittings, machinery and stock are in place, no one should have to travel more than 45m to the nearest alarm point. They should be conspicuous (red) and fitted at a height of about 1.4m and not in an area likely to be obstructed.

Areas that are well stewarded or regularly checked and patrolled may have less need for a manual call point.

In some cases such as a large beer tent, manual call points may need to be avoided in public areas because of the high risk of malicious activations.

Detailed guidance on manual call points is given in BS EN 54-11.⁴¹

2.2 Automatic Fire Detection

Automatic fire detection may be needed for a number of reasons. These can include:

- if you have areas where people are isolated or remote and could become trapped by a fire because they are unaware of its development, such as lone workers;
- if you have areas where a fire can develop unobserved (e.g. storerooms and plant room); and,
- as a compensating feature, e.g. for inadequate structural fire protection, combustible materials forming the enclosure of the space, in dead-ends or where there are extended travel distances;

New automatic fire detection systems should be designed and installed by a competent person in accordance with the advice given in British Standard 5839-1.⁴²

2.3 Staff Alarms, Voice Evacuation and Public Address Systems

Research has shown that some people and, in particular, members of the public do not always react quickly to a conventional fire alarm at large events or when they are in the open air. Public Address (PA) and Voice Evacuation Systems are therefore very important at open-air events as they can give staff and the public explicit information about the emergency or any other actions that they are required to undertake. A message or messages can be relayed to many people at the same time but you must consider carefully the message content. You should consider what information to provide, and how to communicate it succinctly.

The PA announcer should have a good view over as much of the venue as possible and effective communication links with all control points. The PA system may also be vehicle mounted which increases its flexibility.

It is important to establish the required levels of audibility and speech clarity for the system. It is therefore essential to ensure that public address voice-alarm systems are designed and installed by a person with specialist knowledge of these installations.

Staff alarms allow staff to be aware of an incident in advance of the public and be prepared for an evacuation. You may wish to use code words to warn of an evacuation, or of some other actions required. It is important, however, that such communications should not result in a significant reduction in the time available for the public to escape. You should seek advice from a competent person before using a staff alarm system in a marquee or other tented structure because the time allowed for escape is generally less than for permanent structures.

You may wish to provide information to other users of the site, regarding warning signals, escape routes, muster points or other pertinent information, e.g. during induction of new concessions stalls or staff.

Guidance on voice alarm systems can be found in British Standard 5839 Part 8⁴³. Guidance on sound systems used for emergency purposes can be found in BS EN 60849⁴⁴.

2.4 Staged fire alarms

Depending on the size of your event, activating the fire warning system to trigger the immediate and total evacuation of the entire site may be appropriate. However, at large or complex events this may not be appropriate or possible and alternative arrangements may need to be in place.

These alternative arrangements broadly fall into two groups. Firstly, those people potentially most at risk from a fire, usually those closest to where the alarm was activated, will be immediately evacuated, while others are provided with information relevant to their risk from the fire and will only evacuate if it becomes necessary. This is generally called a staged evacuation and the initial movement,

depending on the layout and configuration of the site, will be progressively away from the fire.

The second alternative is for the initial alert signal to be given to certain staff, who then carry out pre-arranged actions to help others to evacuate more easily. It requires able, fully trained staff to be available at all times and should not be seen as a simple means of reducing disruption to the event or venue.

These arrangements require a fire-warning system activated by a site fire safety management team and should only be considered after consultation with the relevant enforcing authority. Such systems also require a high degree of management input to ensure that staff and others are familiar with the system and action required.

2.5 Testing and Maintenance

A named responsible person, given enough authority and training to manage all aspects of the routine testing and scrutiny of the system, should supervise your fire-warning and/or detection system.

All types of fire-warning systems should be tested at a frequency appropriate to your event duration but at least on a weekly basis and before the event of venue opens to the public.

Testing and servicing of the system should be carried out by a competent person on a six monthly basis.

Further guidance on testing and maintenance of fire warning systems can be found in British Standards 5839 Part 1.⁴²

It is good practice to record all tests, false alarms and any maintenance carried out.

Figure 14: Using a test key



2.6 Guaranteed Power Supply

The Health and Safety (Safety Signs and Signals) Regulations 1996⁷ requires that electrical fire warning systems have a back up power supply.

Whatever back up system is used, it should normally be capable of operating the fire-warning and detection system for a minimum period of 24 hours and sounding the alarm signal for 30 minutes.

2.7 New and altered systems

Guidance on the design and installation of new systems and those undergoing substantial alterations is given in BS 5839 – 1.⁴² If you are unsure that your existing system is adequate you will need to consult a competent person.

Section 3 Further guidance on firefighting equipment and facilities

All open air events and venues should be provided with appropriate firefighting equipment. For the majority of premises, first aid firefighting equipment (portable extinguishers) should be sufficient. However, at larger and more complex events or venues, particularly permanent venues, you need to consider providing some form of fixed fire fighting equipment, such as hose reels or water supplies for firefighting, in the form of water mains and hydrants

You have responsibility for the provision of appropriate fire fighting equipment. It is also your responsibility to check that all fire fighting equipment is in the correct position and in satisfactory order before the event or venue is used.

Appropriate staff should be trained in the use of all equipment.

3.1 Portable fire fighting equipment

Fire extinguishers provided should be appropriate to the specific risks found at your event or venue in accordance with Table 2. This table also shows the different classes of fire, according to what is burning.

Table 2: Class of fire

Class of fire	Description
Class A	Fires involving solid materials such as wood, paper or textiles.
Class B	Fires involving flammable liquids such as petrol, diesel or oils.
Class C	Fires involving gases.
Class D	Fires involving metals.
Class F	Fires involving cooking oils such as deep-fat fryers.

Note: If there is a possibility of a fire in your premises involving material in the shaded boxes then you should seek advice from a competent person.

Number and type of extinguishers in enclosures (temporary buildings, tents and marquees etc.)

Typically for the Class A fire risk, the provision of one water-based extinguisher for approximately every 200m² of floor space, (with a minimum of two extinguishers), will normally be adequate. Depending on the outcome of your fire risk assessment, it may be possible to reduce this to one extinguisher in areas with a floor space of less than 90m². Extinguishers provided for general cover should be positioned near exits.

Where it is determined that there are additionally other classes of fire risk, the appropriate type, number and size of extinguisher should be provided. Further information is available in BS 5306-8.⁴⁵

They should be placed on a dedicated stand or hung at a convenient height so that people can easily lift them off (at about 1m for larger extinguishers, 1.5m for smaller ones, to the level of the handle). Ideally no one should have to travel more than 30m to reach a fire extinguisher. If there is a risk of malicious use you may need to use alternative, and more secure locations.

Consider the implications of the Manual Handling Operations Regulations 1992⁴⁶ when selecting and siting fire-fighting equipment.

Extinguishers manufactured to current standards (BS EN 3-7⁴⁸) are predominately red but may have a colour-coded area, sited above or within the instructions, denoting the type of extinguisher.

Most older extinguishers, manufactured to previous standards, have bodies painted entirely in a single colour which denotes the type of extinguisher. These older extinguishers remain acceptable until they are no longer serviceable. However, it is good practice to ensure that old and new style extinguishers are not mixed.

The following paragraphs describe different types of extinguisher. The colour referred to is the colour of the extinguisher or the colour coded area.

Water extinguishers (red)

This type of extinguisher can only be used on Class A fires. They allow the user to direct water onto a fire from a considerable distance.

A 9-litre water extinguisher can be quite heavy and some water extinguishers with additives can achieve the same rating, although they are smaller and therefore considerably lighter. This type of extinguisher is not suitable for use on live electrical equipment.

Water extinguishers with additives (red)

This type of extinguisher is suitable for Class A fires. They can also be suitable for use on Class B fires and where appropriate, this will be indicated on the extinguisher. They are generally more efficient than conventional water extinguishers.

Foam extinguishers (cream)

This type of extinguisher can be used on Class A or B fires and is particularly suited to extinguishing liquid fires such as petrol and diesel. They should not be used on free flowing liquid fires unless the operator has been specially trained, as these have the potential to rapidly spread the fire to adjacent material. This type of extinguisher is not suitable for deep-fat fryers, chip pans or electrical equipment.

Powder extinguishers (blue)

This type of extinguisher can be used on most classes of fire and achieve a good 'knock down' of the fire. They can be used on fires involving electrical equipment but will almost certainly render that equipment useless. Because they do not cool the fire appreciably it can re-ignite. Powder extinguishers can create a loss of visibility and may affect people who have breathing problems and are not generally suitable for confined spaces.

Carbon dioxide extinguishers (black)

This type of extinguisher is particularly suitable for fires involving electrical equipment as they will extinguish a fire without causing any further damage (except in the case of some electronic equipment e.g. computers). As with all fires involving electrical equipment, the power should be disconnected if possible.

Class 'F' extinguishers

This type of extinguisher is particularly suitable for commercial catering establishments with deep-fat fryers.

Selection, installation and maintenance of portable fire extinguishers

All portable fire extinguishers will require periodic inspection, maintenance and testing. Depending on local conditions such as the

likelihood of vandalism or the environment where extinguishers are located, carry out brief checks to ensure that they remain serviceable. In normal conditions a monthly check should be enough. Maintenance by a competent person should be carried out annually.

New fire extinguishers should comply with BS EN 3-7.⁴⁸ Guidance on the selection and installation of fire extinguishers is given in BS 5306-8;⁴⁹ for maintenance in BS 5306-3;⁴⁷ and for colour coding in BS 7863.⁵⁰

Fire blankets

Fire blankets should be located in the vicinity of the fire hazard they are to be used on, but in a position that can be safely accessed in the event of a fire. They are classified as either light-duty or heavy-duty. Light-duty fire blankets are suitable for dealing with small fires in containers of cooking oils or fats and fires involving clothing. Heavy-duty fire blankets are for industrial use where there is a need for the blankets to resist penetration by molten materials.

3.2 Fixed firefighting installations and fire points

Hose reels

Permanent hose reels installed in accordance with the relevant British Standard (BS EN 671-3³⁷) provide an effective firefighting facility. They may offer an alternative, or be in addition to, portable firefighting equipment. A concern is that untrained people will stay and fight a fire when escape is the safest option. Where hose reels are installed, and your fire risk assessment expects relevant staff to use them in the initial stages of a fire, they should receive appropriate training.

Maintenance of hose reels includes visual checks for leaks and obvious damage, which should be carried out regularly, and more formal maintenance checks should be carried out at least annually by a competent person.

Fire points

A fire point is a highly visible location easily recognisable by the people present, that contains equipment to fight fires.

The type of fire fighting equipment will vary according to the local conditions, what is brought on to the site and the risks to be covered. For example, there may need to

be firefighting equipment for tackling fires in vegetation, parking areas, catering facilities and temporary structures. An effective arrangement is to provide well indicated fire points as detailed below:

- where water standpipes are provided on site and there is a water supply of sufficient pressure and flow to project a jet of water approximately 5m from the nozzle, fire points consisting of a standpipe together with a reel of small diameter hose of no less than 30m in length should be provided. The hose should be provided with means of connection to the water standpipe (preferably a screw thread). The hose should end in a small hand-control nozzle. Keep hoses in a box painted red and marked 'FIRE HOSE REEL'
- where standpipes are not provided or the water pressure or flow is not sufficient, provide each fire point with either a water tank at least 250L in capacity fitted with a hinged cover, two buckets and one hand pump or bucket pump;
- alternatively a suitable number of water-type fire extinguishers; and
- in addition, suitable fire extinguishers should be sited adjacent to special risks, e.g. electrical generators powered by diesel.

The number of fire points provided will depend on the equipment provided. Where standpipes and hose reels are provided, they should be located so that they are no greater than 35m from the areas to be covered. Where water tanks and pumps are relied upon they should be located no greater than 25m from the areas to be covered.

3.3 Other Facilities (including those for fire fighters)

At permanent sites Building Regulations² and other Acts, including local Acts, may have required fire fighting equipment and other facilities to be provided for the safety of people in any permanent buildings and to help fire fighters. These may include:

- access roads;
- information and communication arrangements, e.g. fire telephones and wireless systems and information to brief the fire and rescue service when they arrive; and

- firefighters switches.

Fire safety law places a duty on you to maintain such facilities in good working order and at all times.

The Workplace (Health, Safety and Welfare) Regulations 1992⁵¹ also require that systems provided for safety within a workplace are maintained.

Access for fire engines and fire fighters

Access routes to and within the site, sometimes known as fire lanes, should be provided where necessary, and checked to make sure that they can take the maximum weight and wheelbase of fire and rescue service vehicles. Routes will not be adequate for emergency access if:

- they are not of adequate width to allow vehicles to circulate on your site;
- they are fitted with gates that are locked and /or are too narrow;
- bridges or other features over-hanging the access routes which make them impassable by fire and rescue service vehicles;
- road surfaces that deteriorate due to bad weather conditions; and
- manhole covers are not designed for heavy vehicles.

Routes for fire engines should have a:

- road width of not less than 3.7m;
- clear width at gates not less than 3.1m;
- clear height of not less than 3.7m;
- surface that can carry a vehicle weighing 12.5 tonnes; and
- suitable area to allow vehicle to turn around. If a turning circle is provided, have a diameter not less than 16.8m.

Routes likely to be used by emergency vehicles should be kept free of parked vehicles. This should be discussed with the police at the planning stage. Your routes should be located so that no parts of the event where firefighting may be required is greater than 50m from a fire lane or adjacent existing suitable thoroughfare.

Aluminium track way can be useful on soft ground, providing it can take the maximum weight and width of fire service vehicles, especially at changes in direction.

On-site emergency vehicle routes need to be clearly marked and kept free from obstruction. Parking should not be allowed on these internal routes. They should be connected to the primary access points to the site from the public highways.

Ideally, fire and rescue service access routes should not be inter-connected with the public car parks. It may be advisable to define emergency vehicle rendezvous points around the perimeter to where they initially arrive at the site.

Any below ground hydrants and other water supplies should be clearly visible and easily accessible.

You should always liaise with the local fire and rescue service to ensure that your access routes are suitable for the appliances used by that service.

Information and communication arrangements

The effectiveness of the fire and rescue service will be greatly assisted if they are provided with information about your site and its communication systems and control point. The provision of plans indicating the layout of the site, fire service access routes, on site fire fighting equipment and fire hydrants should be considered. Where provided these should be made available to the fire service when they arrive.

Where your site is provided with a communication system which enables messages to be relayed to the people present or staff/stewards, e.g. via public address or radios, you should ensure that the fire service are aware of the presence of these facilities so that they can be used when they arrive on site.

Figure 15: Campsite fire lanes



Firefighters' switches

Safety switches are often needed to isolate high-voltage luminous signs or to cut off electrical power. In the case of existing installations, if they have been provided in accordance with previous legislation (e.g. the Local Government (Miscellaneous Provisions) Act 1982), then it is likely that they will comply with the Order. If this is not the case, then you may need to consult the enforcing authority regarding the suitability of its location and marking. Testing should be carried out in accordance with the manufacturer's instructions. If you have no such instructions then an initial test should be carried out by a competent electrician.

Other fire fighting facilities

As well as those already mentioned, other facilities to assist firefighters may have been installed in your premises and should be properly maintained by a competent person. Your maintenance audit (see Appendix A.1 for an example checklist) should include these. Such facilities may include:

- information signs for firefighters;
- Static water supplies, private hydrants, meter bypass valves and underground tanks; and
- Standby fire pumps and electrical generators.

Section 4 Further guidance on escape routes

Introduction

This section provides further guidance on the general principles that apply to escape routes and provides examples of escape route solutions. You are not obliged to adopt any particular solution for escape routes in this section but you must ensure that your solution is safe and meets the relevant requirements.

Refer to the glossary (Appendix D) for the definitions of any terms you may not be familiar with.

Open-air venues provide facilities whereby people can enjoy activities ranging from small village fêtes or car boot sales with relatively low numbers of people to large international motor racing events or music concerts accommodating very large numbers of people. At any venue there may be many different activities taking place, either entirely in the open air (with or without enclosed or fenced-off areas) or in combination with facilities that are inside, such as temporary enclosures, marquees, temporary structures or permanent buildings. Each of these activities may have a different level of risk, requiring a different approach to the design for means of escape.

In order to apply the guidance in this section, you need to understand that in any fire situation the time that people have to escape before they could become affected by the fire is limited. Providing them with sufficient time therefore means that as well as having appropriate means of detection and warning, any designated escape route needs to have sufficient capacity to discharge the maximum number of people present within a safe time. Additionally, the distance that people have to travel to make their escape might need to be restricted, particularly where the escape route is inside.

The criteria used in this guide to assess the adequacy of escape routes is based on three principles. These are:

- escape time;
- escape route capacity; and
- travel distance.

Escape time is the time within which people must be able to reach a place of reasonable or total safety before they are in danger from a fire. This principle applies in all cases, indoors or outdoors, and the maximum escape time that is appropriate will vary depending on the level of risk (see levels of risk below). Where escape time is used to assess the adequacy of escape routes in the open air, the time allowed includes the time it takes to move people away from the fire, if necessary along any defined escape routes, and includes passing through any restrictions such as gates and barriers. This does not necessarily include the time taken to negotiate the entire exit route beyond the site, because a place somewhere on the site well away from the source of fire may often be adequate.

Escape route capacity is the ability of the escape route to discharge the number of people present to a place of safety within the escape time. Assessment of the escape route capacity is necessary where there are any restrictions on the escape route, such as doors, fences and gates, corridors and passageways, regardless of whether the route is indoors or outdoors.

Travel distance (see Glossary) is the distance that people have to travel to reach an exit in 'indoor' situations. Because of the higher risk of being cut off by a fire indoors, the escape time is more limited and has to include the time it takes to travel to an exit. Restricting the travel distance according to the level of risk is therefore used to ensure that sufficient time is available for escape in indoor situations.

Where a venue or event has a combination of outdoor and indoor activities, an assessment of the escape routes will need to be based on all three of the above criteria as appropriate. More detailed guidance on these matters is provided later in this section.

Levels of risk

To check that your escape routes are adequate (after you have taken other risk reduction measures), you will first need to form a

judgement about the level of risk from fire that people may be at in any part of your event or venue.

Outdoors

The risk to people from fire outdoors may generally be viewed as lower than that in an indoor situation, simply because people are less likely to be affected by smoke and heat and their escape routes are much less likely to be cut off.

The chance of a fire starting is increased where significant sources of ignition are likely to be present, e.g. hot food concessions, petrol generators or extensive electrical equipment, therefore the likelihood of people being at risk from fire is greater, particularly where a high density of structures and other installations could promote the spread of fire, or highly flammable or explosive materials are present. Even where the chance of a fire starting is initially low, any fire starting in certain areas might cause a significant risk to people, e.g. from hazards such as gas cylinders that can explode and fragment into projectiles when heated. Where significant additional facilities such as marquees/tents, temporary structures and static or mobile concessions are likely to be found on-site, you need to consider the risk to people from radiated heat from a fire in one of these. You also need to consider the time required to move people away from the vicinity of these facilities to enable the occupants to escape from a fire inside, as crowded or poorly designed circulation spaces around such facilities can cause a significant delay to those escaping. In all these examples, fast dispersal of people to a safe distance from the fire will be necessary; the risk level in these areas might therefore be regarded as **'higher'**. Typical examples might include certain areas of larger venues and events such as music concerts and sporting events with large numbers of people and extensive facilities, where the site is enclosed and movement is restricted for security reasons.

In areas where there is little chance of a fire, or, if a fire does start, it will be detected quickly so that people can escape safely and it is unlikely to spread quickly, e.g. because the density of structures and installations is low and no additional hazards are likely to become involved, the risk might be regarded as **'lower'**. Typical examples might include small village fêtes and other similar events accommodating limited numbers of people

predominantly in the open air, with very few sources of ignition and combustible materials and with unrestricted egress from the site.

In practice, your venue or event is likely to comprise a number of different areas of risk, ranging from lower to higher, in which case you will need to assess these separately and plan your fire precautions accordingly. For example, where people can move away from a hazard with ease, the risk level might be regarded as lower than if movement away from the same hazard is restricted by fences, site layout or other obstructions.

In the majority of outdoor areas of typical venues or events, other than those meeting the type of criteria described above, it is likely that the risk level can be regarded as **'normal'**.

Indoors

Inside a tent, marquee or other temporary structure where there is a likelihood of a fire starting and spreading quickly (or a fire could start and grow without being quickly detected and a warning given) and affecting the escape routes before people are able to use them, then the risk should normally be regarded as **'higher'**. Such areas could include those where significant quantities of flammable materials are used or stored; ready sources of ignition are present (e.g. catering equipment); significant numbers of people are present (e.g. a beer tent) or are likely to move slowly or be unable to move without assistance; and the construction provides hidden voids through which a fire could spread quickly (e.g. stage seating in a circus big top). In such circumstances you should consider reducing the travel distances as suggested in Table 5 on page 70.

Where there is a low occupancy level and all the occupants are able-bodied and capable of using the means of escape without assistance; very little chance of a fire; few, if any, highly combustible or flammable materials or other fuels for a fire; fire cannot spread quickly and will be detected quickly so people will quickly know that a fire has occurred and can make their escape, then the risk can usually be regarded as **'lower'**.

In most cases, however, the risk will usually be **'normal'**.

The travel distances suggested are not hard and fast rules and should be applied with a degree

of flexibility according to the circumstances. For example, where the risk might otherwise be considered 'normal' but where there are a significant number of people who move slowly or may need assistance to evacuate, it would usually be appropriate to consider this a 'higher' risk. However, where other measures are in place to mitigate this, such as the availability of extra assistance, and this has been planned for in your emergency plan, it may be that the risk level can be regarded as 'normal to higher'.

Equally, where the risk category would otherwise be 'lower' but for the fact that a small number of occupants may move slowly or need assistance, it may be appropriate to categorise the risk as 'normal' in these circumstances.

If you are not sure about the level of risk in any area of your event or venue, you should seek advice from a competent person.

4.1 General principles

Escape routes

Escape routes, whether internal or external, need to be designed so that people can escape quickly enough to ensure that they are not placed in any danger from fire. The time available will depend on a number of factors, including the number of escape routes available, the nature of the occupants, the number of exits and the rate of fire spread. Smooth, unimpeded flow through an escape route is best achieved by ensuring that the route does not narrow along the length.

Suitability of escape routes

You should ensure that your exits and escape routes, whether outdoors or indoors, are:

- suitable;
- easily, safely and immediately usable at all relevant times;
- adequate for the number of people likely to use them and that you have considered 'discounting' those routes or exits that may be affected by fire;
- free from any obstructions, slip or trip hazards (consider adverse weather conditions);
- sited away from marquees to avoid trip hazards from guy ropes and stakes. Where necessary, barriers should be provided;

- clearly indicated and, if they consist of wall flaps, are of a quick release design, clearly defined at the edges and so arranged as to be easily and immediately opened from the inside; and
- available for access by the emergency services.

Gates and doors that are final exits, and all gates or doors leading to such exits, should be checked before an event starts to ensure that they:

- are unlocked and, in those circumstances where security devices are provided, can be opened easily and immediately using a suitable means from within without the use of a key;
- are free from obstructions; and
- open outwards in the direction of escape.

Where ramps are used they should have a:

- constant slope not broken by steps;
- gradient appropriate to the number and type of persons using them;
- guard rail and a handrail; and
- non-slip surface.

When considering assembly areas you should ensure that:

- you have defined assembly areas outside the event boundary, where this is appropriate;
- the location does not obstruct or interfere with emergency services access routes; and
- they are of sufficient size and are clearly identifiable by appropriate signage.

When open, no door should obstruct any gangway, passage or stairway. More detailed recommendations are given in the Guide to Safety at Sports Grounds.¹¹ If in doubt consult a competent person.

Fire-resisting construction

Where your event or venue involves accommodating people in enclosed temporary structures (e.g. Portakabins that have been joined together to provide accommodation), you need to ensure that the occupants are safe, where necessary, by protecting the internal escape routes from the effects of a fire. Where an escape route needs to be separated from the rest of the premises by fire-resisting construction, e.g. a dead-end corridor in a Portakabin, then you should ensure the following:

- Doors (including access hatches to cupboards and ducts), walls and ceilings protecting escape routes should be capable of resisting the passage of smoke and fire for long enough so that people can escape from the building.
- Where suspended or false ceilings are provided, the fire resistance should extend up to the floor/roof slab level above. For means of escape purposes a 30-minute fire-resisting rating is usually enough.
- Cavity barriers, fire stopping and dampers in ducts are appropriately installed.

If there is any doubt about the nature of the construction of your premises, ask for advice from a competent person.

Number of people attending the event

As your escape routes need to be adequate for the number of people likely to use them, you will first need to consider how many people, including staff, public and others such as contractors, may be present at any one time.

For some events the maximum numbers of people likely to be present will be known, e.g. where the event is ticketed or limited by seating.

If occupant numbers are not known (e.g. at non-ticketed or non-seating events), a simple calculation can be performed in order to determine the maximum operating capacity using the formula below (see Table 3 for appropriate occupant density).

$$\text{Number of people} = \frac{\text{Occupied area (m}^2\text{)}}{\text{Occupant density}}$$

Table 3: Occupant densities

Occupied area type	Typical occupant density m ² /person
Standing spectator/audience area or bar (unseated)	0.3
Assembly area, dance floor or hall	0.5
Dining area, seated bar or restaurant	1.0
Skating rink or sports area	2.0
Display gallery or workshop	5.0
Camping area	6.0
Sales area	2.0
Car park	two persons per parking space

In practice, you will need to perform this calculation for each separate area.

When calculating capacity, ensure that allowance is made for areas taken up by facilities such as food or merchandising stalls and temporary structures, as people cannot use these areas. Whatever the results of the calculation, the permitted capacity should never exceed the capacity of the available escape routes (see width and capacity of escape routes below).

If in doubt about calculating the capacity of your event or venue, you should consult a competent person.

Mobility impairment

The responsible person for outdoor events needs to consider how people with disabilities can best be accommodated. Provisions should include easy access and adequate means of escape for use in an emergency. The number who can be admitted will need to be agreed by the enforcing authority and will be dependent upon a number of factors, such as structural and internal layout of the site or venue. The provision of wheelchair spaces in different parts of seating areas, such as pop concerts and the like, helps wheelchair users to have a choice of location. At such an event, you will need to make provision for when a disabled person transfers from a wheelchair to a seat; provision also needs to be made for the wheelchair to be readily accessible without it causing an obstruction in a gangway or exit route. However, should a person wish to remain in their wheelchair, ensure that the position will not obstruct others in the event of an emergency.

In addition, the following points should be considered:

- Where refuges are provided, they should be enclosed in a fire-resisting structure which creates a protected escape route which leads directly to a place of total safety and should only be used in conjunction with effective management rescue arrangements. Your fire safety strategy should not rely on the fire and rescue service rescuing people waiting in these refuges. Sufficient escape routes should always be available for use by disabled people. Staff should be aware of routes suitable for disabled people so that they can direct and help people accordingly.
- Emergency plans should allow for the assistance of or careful carrying of disabled people without their wheelchairs, should the wheelchair be too large or heavy, particularly where the terrain may be uneven, rough, or soft due to rain. You will need to take into account health and safety manual handling procedures in addition to the dignity and confidence of the disabled person.
- Where ramps are necessary for the emergency evacuation of people in wheelchairs, they should be as gentle as possible.

Further guidance is available in BS 5588-8⁷⁶ and BS 5588-12³⁹ and Approved Document M.⁸⁶

Childcare facilities/crèches

The location of childcare facilities/crèches is important since parents or guardians will often seek to return to the facility when the alarm sounds. It is therefore important that the facility is located so as to avoid parents travelling against the normal direction of escape.

Places of safety

Your choice of a place of safety should be based on people's exposure to the fire hazard. If a fire involves an outside barbeque and a small number of people, the place of safety may be a few metres away. If a fire involves gas cylinders or aerosols and there are a large number of people, the place of safety may need to be a few hundred metres away.

Where people have escaped from an inside space, such as a marquee, to a place of reasonable safety in the open air, you need to consider the impacts of the activities around the marquee to ensure that they do not impede people's movement away from the hazard. For example, if a marquee's exits discharge to an area with food concessions which is congested, this could prevent the free flow of people out of the marquee even when its exits are sized according to the number of people inside. In this case you should consider how to manage the crowd in the open air so that they move away from the unseen hazard or ensure that your place of relative safety is free from any obstructions.

Width and capacity of escape routes

It is important to provide enough exits of sufficient width that are capable of safely accommodating the passage of people within an acceptable period of time, to avoid congestion and psychological stress.

Exit systems may comprise gangways, stairways, passageways, gates, openings, ramps and other means of passage.

Once you have established the maximum number of people likely to be in any part of the event or venue, the next step is to establish that the capacity of the escape routes is adequate for people to escape safely and in sufficient time to ensure their safety in case of fire.

The capacity of a route is determined by a number of factors including the width of the route, the time available for escape, the rate of passage of people through the route per minute and the ability of the people using them.

To establish the capacity of the route, it is first necessary to measure the width of the route at the narrowest point. The effective usable width of an escape route through which people can pass is the narrowest clear unobstructed width at any point, normally a door, gate, route between concessions, aisle or other restriction, such as marquee guy ropes.

When calculating the overall available escape route capacity for an event or venue that has more than one way out, you should normally assume that the widest is not available because it has been compromised by fire. If doors or other exits leading to escape routes are too close to one another you should consider whether the fire could affect both at the same time. If that is the case, it may be necessary to discount them both from your calculation.

Escape routes – outdoors

At open-air sites or venues it is normally necessary to assess the adequacy of escape routes by considering the appropriate escape time and the capacity of the escape routes. However, for some low risk areas where there is unrestricted access for people to move to a place of reasonable safety, it may not be necessary to apply all the guidelines in this section.

Escape times

Escape times may be only a proportion of the total evacuation time for your event as people move progressively away from the fire. The escape time will most likely be the time taken to move to a place of relative safety within the event boundaries, while the evacuation time is most likely the time taken to empty the event. Care should therefore be taken in the use of

the terms to describe escape or evacuation times and to what part of your event or venue they apply.

The information in this section is provided to demonstrate the range of escape times available to you in the assessment of your event and is derived from the guidance provided in the Guide to Safety at Sports Grounds.¹¹

The maximum escape time for open-air events can vary between 5 and 10 minutes. The times suggested (see Table 4) depend largely on the level of fire risk present (see levels of risk on p 63). Where the open-air event has a higher risk, escape routes should be based on an escape time of not more than 5 minutes. Where the open-air event has a lower fire risk, escape routes may be based on an escape time of up to 10 minutes.

Table 4: Open-air escape times

Risk	Time
Higher	< 5 minutes
Normal	> 5 < 10 minutes
Lower	< 10 minutes

Escape route capacities

The capacity of an escape route is determined by the rate at which people pass along the route during each minute of the defined escape time. The following are suggested rates of passage for open-air parts of venues:

- on all routes within seated accommodation (including gangways and ramps) and stairways – 73 people/metre/minute; and
- on all routes in other parts of the event or venue (including within standing accommodation) – 109 people/metre/minute.

The width and capacity of the escape routes required for the number of people present can be calculated by using the formula:

$$\text{Total exit width} = \frac{\text{number of people}}{\text{flow rate} \times \text{escape time}}$$

An example calculation is shown below:

Example calculation

There are 4,000 ticketed people at a horticultural show and 200 exhibitors. Marquees are provided, which contain very low fire risks in the form of flower and vegetable displays. The outdoor area is arranged as a series of display gardens through which people can walk freely along pre-arranged access routes. There is one main entrance point and four other emergency exits are available. One exit is located too near the temporary storage area; the others are a considerable distance from any fire risk.

For the open-air displays, you consider that the risk is low and a 10-minute escape time is appropriate.

What is the exit width requirement for the event?

Step 1 Determine risk level

In this case the risk is considered low

Step 2 Determine escape time

Low risk = 10 minutes (This is the escape time for outside. The escape routes from within marquees and other temporary structures should be assessed by using travel distances, see Escape routes – indoors.)

Step 3 Determine exit flow rate

On the flat area = 109 persons/metre width/minute

Step 4 Determine occupancy

Ticketed event, therefore 4,000 people plus 200 exhibitors = 4,200 maximum

Step 5 Determine total exit width required

Total exit width required = $4,200/109/10 = 3.85\text{m}$

Step 6 Determine minimum number and size of exits required

Minimum width of an exit is normally required to be at least 1.05m, therefore the minimum number of exits required (1.05m wide) is $3.85\text{m}/1.05\text{m} = 4$ exits

However, assuming one exit is compromised by fire, the minimum number of exits (of minimum width 1.05m) = $4+1 = 5$ exits

Note: The minimum number of exits can be reduced by increasing the individual exit widths, provided that the number of exits available (after discounting the largest) is at least two, and their aggregate width is at least 3.85m.

You should complete the exercise for different possible locations of a fire around your venue/event to make sure that the number of available escape routes and the width of exits are sufficient for all potential fire scenarios.

The assessment should also take into account the availability and location of places of safety, and the proximity to structures and installations.

Further guidance on assessing the escape routes at open-air events and venues is available in the Event Safety Guide¹⁰ or the Guide to Safety at Sports Grounds.¹¹

Escape routes – indoors

The time available for escape in an indoor situation depends on several factors, including the distance that has to be travelled to reach a place of safety and the risk rating of the premises. Established reasonable escape times are 2 minutes for higher risk premises,

2.5 minutes for normal risk premises and 3 minutes for lower risk premises. For calculation purposes these times are allowed for in the travel distances suggested in Table 5.

The following guide can be used to determine the general capacities of escape routes:

- From any marquee or temporary structure, the minimum width of any exit should be not less than 1.05m.
- A single exit is suitable for a maximum of 60 people.
- Where more than 60 people are accommodated, there should be not less than two exits, separated by a distance which limits the possibility that both will be affected by a fire at the same time.

- The aggregate width of all the available escape routes (assuming the largest one is unavailable due to fire (except in the case of a single exit)) must be capable of accommodating the maximum number of people likely to use them.

An exit width of at least 1.05m can accommodate up to:

- 160 people in higher risk premises;
- 200 people in normal risk premises; or
- 240 people in lower risk premises.

An additional 75mm should be allowed for each additional 15 persons (or part of 15).

Travel distance

Having established the number and location of people and the exit capacity required to evacuate them safely, you now need to confirm the number and location of exits required. This is normally determined by the distance people have to travel to reach them.

Table 5 gives guidance on travel distances. However, it should be understood that these distances are flexible and may be increased or decreased depending on the level of risk after you have put in place the appropriate fire-prevention measures (Part 1, Step 3.3).

When assessing travel distances you need to consider the distance to be travelled by people when escaping, allowing for walking around tables, chairs, stalls, equipment, etc. The distance should be measured from all parts of the premises to the nearest place of reasonable safety.

The suggested travel distances may be increased by the addition of further fire protection measures, e.g. structural fire protection or automatic fire detection. In these circumstances you should consult a competent fire safety expert.

Where your route leads to more than one final exit, but only allows initial travel in a single direction (e.g. from a room or dead end, see Figures 19 and 20), then this initial travel distance should be limited to that for a 'single escape route' in Table 5. However, your total travel distance should not exceed that for 'more than one escape route'.

Table 5: Suggested travel distances

Type of structure	Escape route	Suggested travel distance
Marquee or tent	Where more than one escape route is provided	18m
	Where only a single escape route is provided	6.5m
Pneumatic structure	Where more than one escape route is provided	12m
	Where only a single escape route is provided	not applicable
Other temporary enclosure	Where more than one escape route is provided	25m in higher fire risk areas 45m in normal fire risk areas 60m in low fire risk areas
	Where only a single escape route is provided	12m in higher fire risk areas 18m in normal fire risk areas 25m in low fire risk areas

Further guidance on travel distances is given in the Event Safety Guide.¹⁰

Note: For assessing the escape routes in more complex temporary structures, including those on more than one level with stairways, etc. and in any permanent structures, you should refer to the appropriate guide in this series (see back cover).

Measuring travel distance

The figures that follow are schematic only. The route taken through a room or space will be determined by the layout of the contents (Figure 16). It is good practice to ensure that routes to the exits are kept as direct and short as possible. In a small room there may be only one exit, but in a larger room or area there may be many exits. In some cases, where the contents are moved around or the space is liable to frequent change, you should ensure that the exits and the routes to them do not become blocked and that the length of the route is not significantly extended.

Figure 16: Measuring travel distance

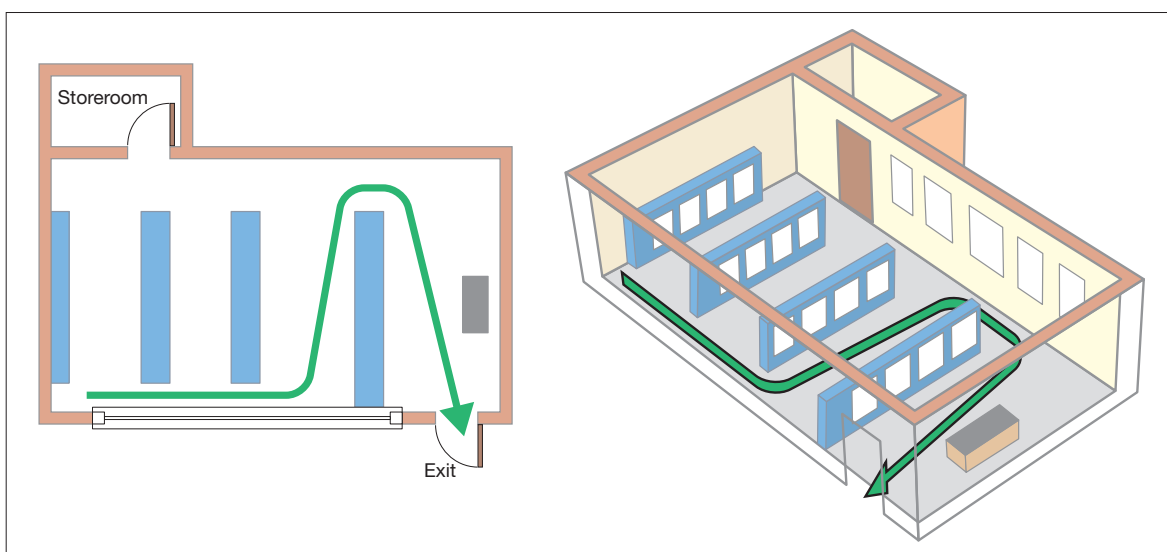

Inner rooms

Where the only way out of a room is through another room (Figure 17), an unnoticed fire in the outer room could trap people in the inner room. This layout should be avoided where possible. If, however, this cannot be achieved then adequate warning of a fire should be provided by **any one** of the following means:

- a vision panel between the two rooms providing adequate vision to give an indication of the conditions in the outer room and the means of escape;
- a large enough gap between the dividing wall and the ceiling, e.g. 500mm, so that smoke will be seen; or
- an automatic smoke detector in the outer room that will sound a warning in the inner room.

In addition, the following points should also be considered:

- Restrict the number of people using an inner room to 60.
- Access rooms should be under the control of the same person as the inner room.
- The travel distance from any point in the inner room to the exit from the access room should be restricted to escape in one direction only, unless there are alternative exits from the access room.
- No one should have to pass through more than one access room while making their escape.
- The outer room should not be an area of high fire risk.

Figure 17: Inner rooms

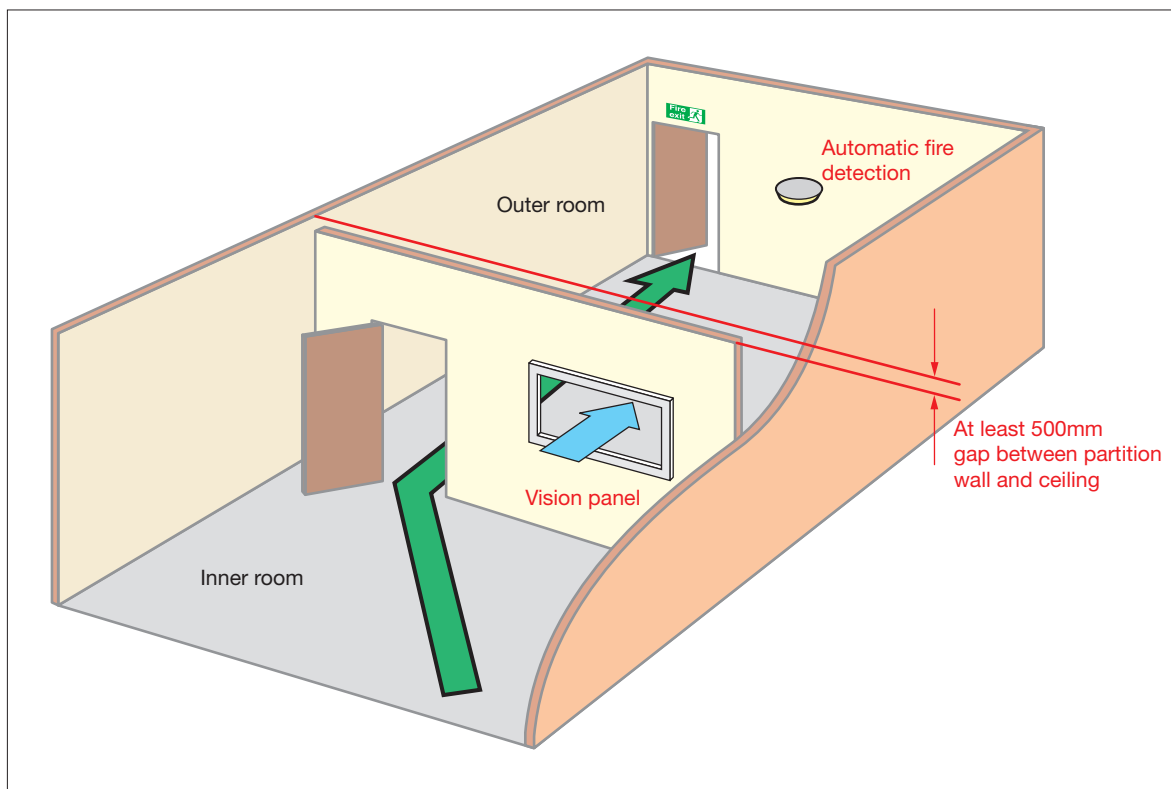

Alternative exits

Where alternative exits from a space or room are necessary, they should, wherever possible, be located at least 45° apart (see Figure 18). If in doubt consult a competent person.

Figure 18: Alternative exits

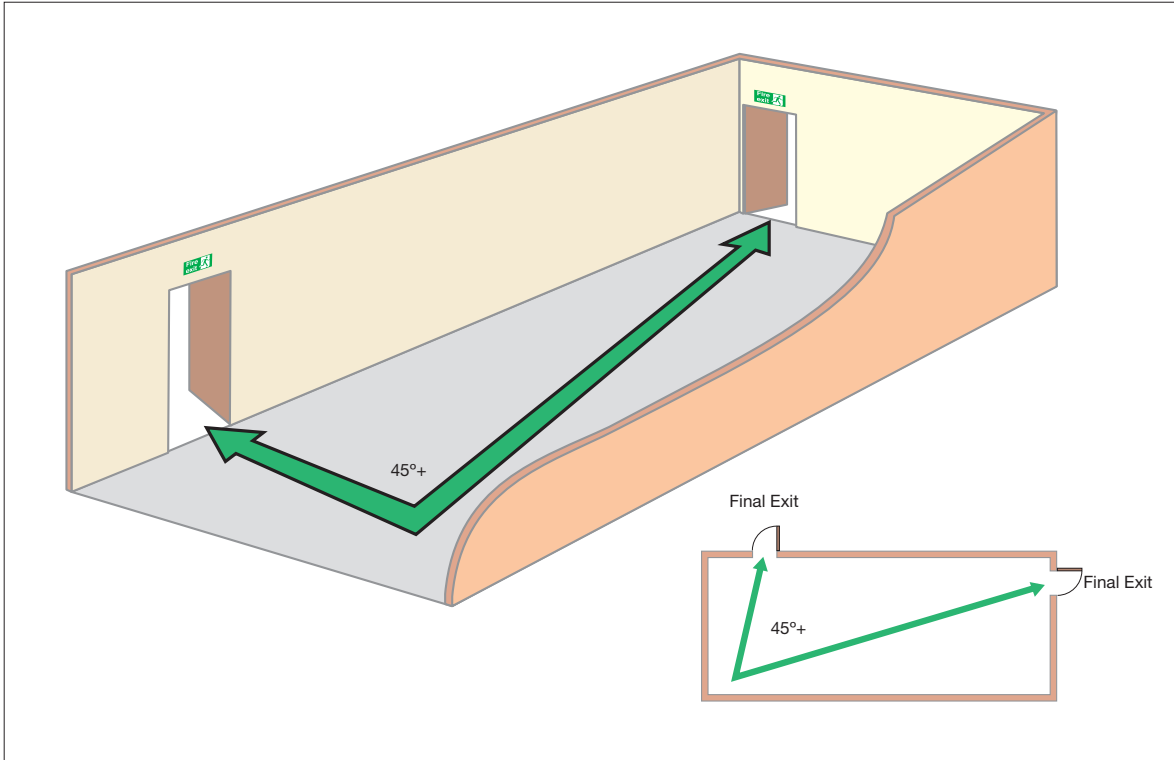

Measuring travel distances for initial dead-end travel

Where the initial direction of travel in an open area (see Figure 19) is in one direction only or within an inner room (see Figure 20), the travel distance (A-B) should be limited to that for a 'single escape route' in Table 5. This may be the case where you have a number of temporary structures or buildings.

Any alternative exits should be positioned to ensure that a fire will not compromise both exits. The maximum total travel distance recommended in Table 5 should apply to the nearest exit (Figures 19 and 20, distance A-C). However, since there are two exits, the total travel distance should not exceed that for 'more than one escape route' in Table 5.

Figure 19: Measuring travel distance from initial dead end (open plan)

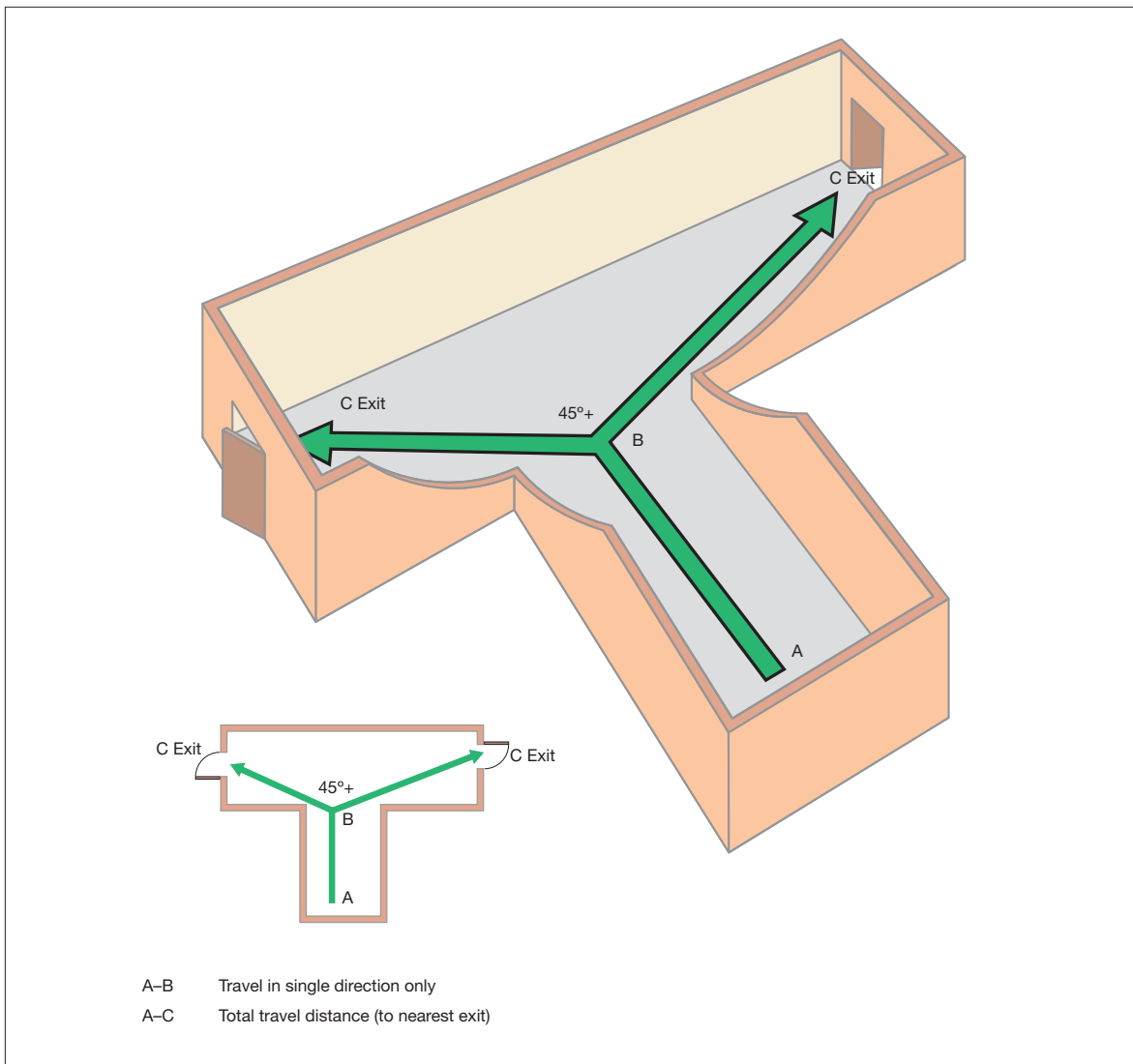
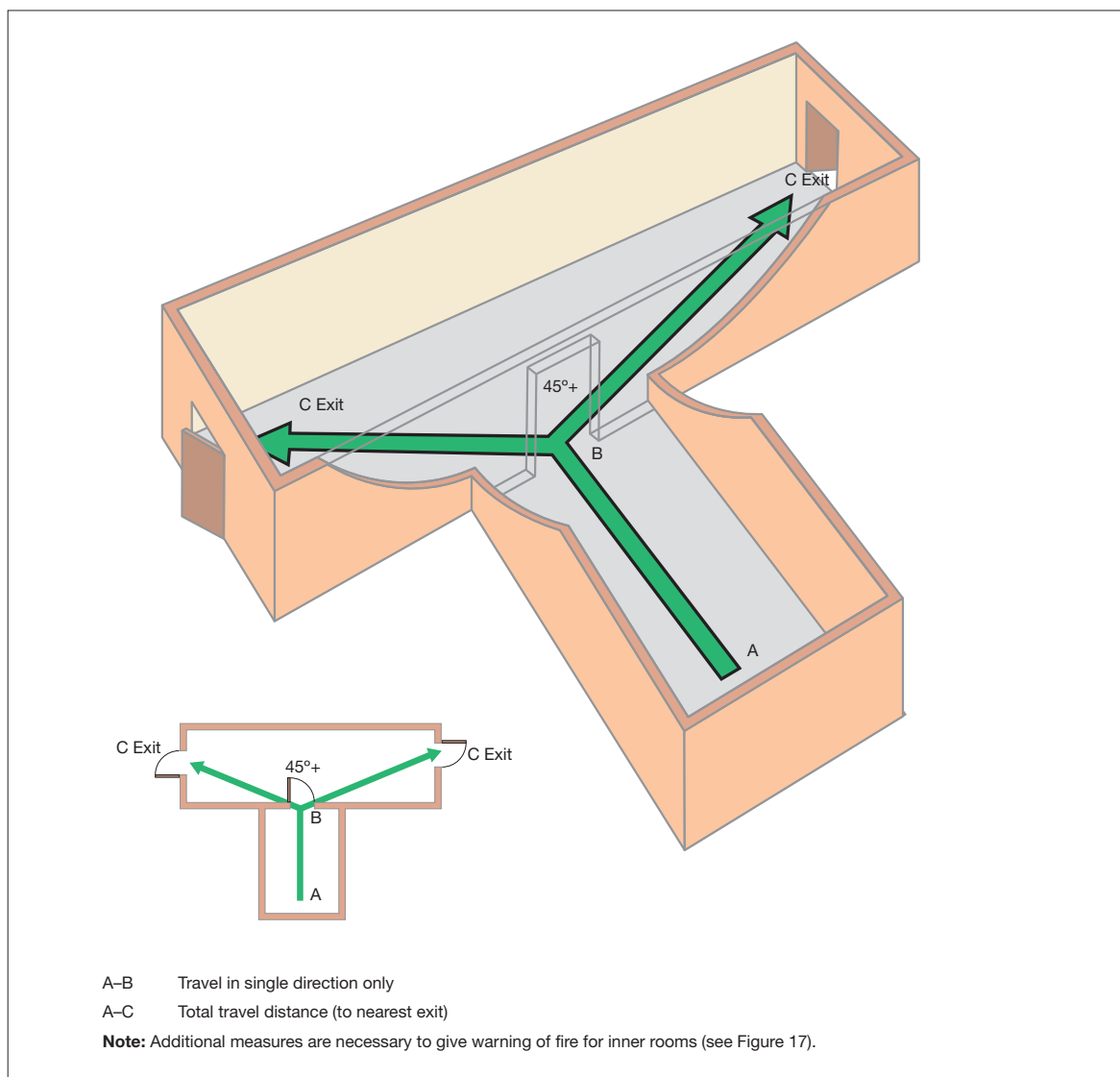

Figure 20: Measuring travel distance from initial dead end (inner room)



Revolving doors, wicket doors, sliding doors and roller shutters

Revolving doors should not normally be considered as escape doors unless the leaves fold outward to form a clear opening upon pressure from within, or standard doors of the required exit width are provided next to the revolving door.

Ideally, wicket doors or gates should have a minimum opening height of 1.5m. The bottom of the door should not be more than 250mm above the floor and the width should be preferably more than 500mm but not less than 450mm. Normally, wicket doors will only be suitable for up to 15 members of staff; however, in areas of a higher fire risk, this should be reduced to a maximum of three.

Shutters (roller, folding or sliding), up-and-over doors and similar openings are not normally suitable for use as a final exit. However, they may be suitable for escape from areas of normal risk by small numbers of staff as long as they are not likely to be obstructed and can be easily and immediately opened manually, even if normally power-operated), and the staff are familiar with the escape routes.

Sliding doors are not normally suitable on escape routes unless they are for the sole use of members of staff. Where provided, a notice with the words 'slide to open', with an arrow pointing in the direction of opening, should be permanently displayed at about eye level on the face of doors.

Final exit doors and escape away from temporary structures

Good escape routes to a final exit will be of little benefit if the occupants are not able to get out of the temporary structure (e.g. tent/marquee) and quickly disperse from the area to a place of total safety. It is also important to consider where people will go once they have evacuated the structure.

The matters that you should consider include the following:

- Final exit doors should open in the direction of escape and be quickly and easily openable without a key or code in the event of a fire. Where possible, there should be only one fastening. See Appendix C for more information on security fastenings.
- Final exit doors should not lead people into an enclosed area from which there is no further escape.
- Where a final exit discharges into an enclosed area, further access to a place of total safety should be available by means of further doors or gates that can be easily opened in a manner similar to the final exit.

You should ensure that exit routes are planned and managed safely, to provide people with a smooth, unimpeded passage through an exit system until they reach a place of safety.

Smooth, unimpeded flow through an exit route is best achieved by ensuring that the exit system does not narrow along its length. If, at any point along the route, there are elements narrower than those preceding, constriction can occur, causing people to converge in the narrower points. In addition, controlling the flow of people at the beginning of the exit routes, e.g. in spectator areas, is vital to ensure that people enter the exit system at an acceptable rate.

You are responsible for ensuring that emergency evacuation routes are capable of being safely and effectively used at all times when the event or venue is occupied. This requires such routes to be maintained as sterile areas, free from any blockages, temporary fittings or stored equipment.

Exit routes from marquees, tents and temporary structures may be over uneven ground or temporary flooring, duckboards or ramps. These factors should be taken into account

to ensure that there are safe egress routes. They may also slow down the speed at which people move and you should consider this effect when assessing travel distances or exit width requirements, e.g. you may wish to reduce the travel distances or increase the exit width. If in doubt, seek advice from a competent person.

Provision of gates or openings in an arena perimeter barrier

Where a perimeter barrier is in place and the arena is used as part of the escape route, it should be fitted with gates or openings allowing egress in an emergency from the area of activity.

If a viewing area is divided by structural means, each division should have sufficient gates or openings to evacuate all the spectators in that division. When open, no door or gate should obstruct any gangway, passage or stairway.

Further guidance on gates and openings is available in the Guide to Safety at Sports Grounds.¹¹

Seating and gangways

The type of seating arrangements adopted will vary with the use to which the event or venue is put. Venues should only be used for closely-seated audiences if your risk assessment shows that it is safe to do so.

Where your event or venue is licensed, there may be additional conditions in the licence concerning how seating may be set out.

Audiences seated in rows will first have to make their way to the end of the row before being able to use the escape routes provided. Seating and gangways in an assembly space should therefore be so arranged as to allow free and ready access direct to the exits.

In fixed seats, there should be a clear space of at least 305mm between the back of one seat and the front of the seat behind it (or the nearest point of the seat behind it, for automatic tip-up seats, see Figure 21). Gangways should be adequate for the number of seats served and at least 1.05m wide. There should be no projections that diminish these widths.

In general, no seat should be more than seven seats away from a gangway. If temporary seating is provided, it should be secured in

Figure 21: Clear space between seating

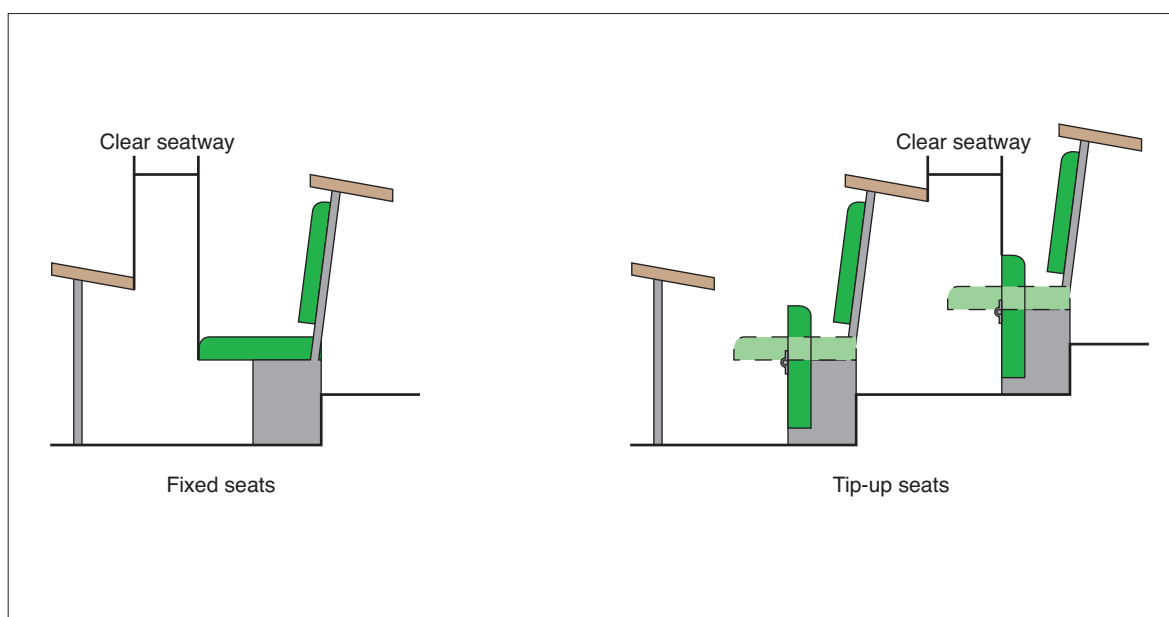

lengths of not fewer than four seats (and not more than 12). Each length should be fixed to the floor.

Standing and sitting in gangways, or in front of any exit, should not be permitted.

If booster seats are provided for small children that will prevent seats returning to an upright position, you need to consider the implications on means of escape.

For sports grounds, you should consult the Guide to Safety at Sports Grounds.¹¹ Detailed information of seating layout is given in BS 5588-6.⁷²

Temporary stands

Temporary stands should be constructed to include a minimum of two readily accessible alternative exit routes, which should be adequately indicated by exit and directional exit signs. If an entertainment extends beyond daylight hours, temporary stands should be provided with normal and emergency escape lighting.

The structure of temporary stands should have adequate resistance to the rapid spread of fire, heat and smoke, as should any fixtures and fittings. Litter and combustible refuse should not be stored or allowed to accumulate beneath a temporary stand.

Concessions and sanitary conveniences should not normally be situated on or attached to temporary stands. If this is unavoidable, any concessions, etc. should be separated from the viewing area and exit routes by fire-resisting construction, and located so as not to obstruct the escape routes.

Note: You must seek specialist advice before assembling a temporary stand.

Use of the central area of activity for emergency evacuation

In certain cases, forward evacuation into the central area of activity may form part of the emergency evacuation route, provided that it leads directly to an exit which itself leads to a place of total safety. Similar considerations should be applied regarding the means of escape from the central area of activity when it is used to accommodate members of the public (e.g. spectators).

Any perimeter barrier in front of public accommodation should be fitted with a sufficient number of suitably designed gates or openings.

Where the surface is made of synthetic materials, advice from the supplier should first be sought to establish whether it can be safely considered as an emergency exit route in the event of a fire. This is because some forms of surface (e.g. artificial turf) might constitute a hazard in the event of a fire.

Section 5 Further guidance on emergency escape lighting

The primary purpose of emergency escape lighting is to illuminate escape routes, but it also illuminates safety equipment.

The size and type of your event, venue or site and the risk to the occupants will determine the complexity of emergency escape lighting required.

In all cases, where the event or venue is used in hours of darkness, it will be necessary to provide sufficient primary illumination for general safe movement and in particular to illuminate all escape routes and exits. In some exceptional cases, ambient light from adjacent areas, e.g. street lighting, might be sufficient but in most cases a separate source of electrically powered lighting will be necessary. Where mains power is not available, power will need to be provided from another source, e.g. central generator or individual generator powered lighting units.

Whatever the primary source of power, a back-up power supply will also be necessary in case of primary power failure. Any back-up power supply should be capable of automatic operation in the event of a failure to the primary supply.

Figure 22: Luminaires

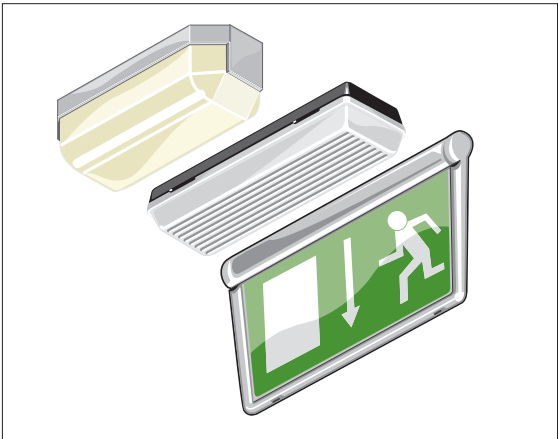

Single 'stand-alone' emergency escape lighting units (luminaires) may be sufficient in a marquee or other temporary structure and these can sometimes be combined with exit or directional signs (see Figure 22). The

level of general illumination should not be significantly reduced by the sign. In larger, more complex events or venues a more comprehensive system of fixed automatic emergency escape lighting is likely to be needed. This will be particularly true for sites where there are significant numbers of staff and members of the public.

In some open areas an efficient and effective method of illuminating escape routes in an emergency is by using spotlights. These are normally self contained units consisting of a battery, switching mechanism and spotlights (see Figure 23) fitted to operate automatically on a circuit or mains failure. However, this type of unit will need a primary power supply.

These self-contained units can be suspended from roofs, structural steelwork such as columns or beams and are capable of illuminating escape routes easily. They should be located at high level and point downward.

Figure 23: Self-contained flood lights



Alternatively, mains or generator powered floodlights, with a suitable back-up power supply, may be acceptable.

You will have identified the escape routes when carrying out your fire risk assessment and need to ensure that they are all adequately lit. If there are escape routes that are not permanently illuminated, then a switch, clearly marked 'Emergency escape lighting', or some other means of switching on the lighting should be provided at the entry to that area.

An emergency escape lighting system in a marquee, tent or other temporary structure should normally cover the following:

- each exit door;

- escape routes;
- assembly areas;
- intersections of escape routes;
- emergency escape signs;
- stairways and steps so that each flight receives adequate light;
- changes in level;
- windowless rooms and toilet accommodation exceeding 8m²;
- fire fighting equipment;
- fire alarm call points;
- equipment that would need to be shut down in an emergency; and
- areas greater than 60m².

It is not necessary to provide individual lights (luminaires) for each item above, but there should be a sufficient overall level of light to allow them to be visible and usable.

Emergency escape lighting can be both ‘maintained’, i.e. on all the time, or ‘non-maintained’ which only operates when the normal lighting fails. Systems of individual luminaires are designed to operate for durations of between one and three hours. In practice, the three-hour design is the most popular and can help with maintaining limited continued use of your event during a power failure (other than in an emergency situation).

Emergency escape lighting (luminaires) can be stand-alone dedicated units or incorporated into normal light fittings. There are highly decorative versions of these for those areas that demand aesthetically pleasing fixtures. Back-up power supplies can be rechargeable batteries integral to each unit, a central battery bank or an automatic start generator.

Emergency escape lighting by gas or other means not using electricity

In premises where escape lighting by gas or other means not using electricity is already installed, the escape lighting should be equivalent to that powered by electricity. Appropriate safety measures should be provided, for example with regards to fixing, location of combustible materials, protection from draughts and emergency shut-off.

Lighting for special effects

Lasers, strobes or other form of high intensity lighting are not suitable for emergency use.

Lighting conditions for stair treads

Where lighting conditions render it desirable the nosings of all stair treads should be made conspicuous by painting or other effective means. Guidance is available in BS 8300.³⁸

Maintenance and testing of emergency escape lighting

All permanently installed emergency escape lighting systems should be regularly tested and properly maintained to an appropriate standard. Most existing systems will need to be manually tested. However, some modern systems have self-testing facilities that reduce routine checks to a minimum.

Depending on your type of installation you should be able to carry out most of the routine tests yourself. The test method will vary. If you are not sure how to carry out these tests you should contact your supplier or other competent person.

Test facilities often take the form of a ‘fishtail’ key inserted in a special switch either near the main fuse board or adjacent to relevant light switches (see Figure 24).

Typically, testing would include:

- a daily visual check of any central controls;
- a monthly function test by operating the test facility for a period sufficient to ensure that each emergency lamp illuminates; and
- an annual full discharge test.

Particular care needs to be taken following a full discharge test. Batteries typically take 24 hours to re-charge and the event or venue should not be re-occupied until the emergency lighting system is fully functioning unless alternative arrangements have been made. It is good practice to keep a record of tests.

Further guidance on maintenance and emergency escape lighting is given in BS 5266-8⁵² and BS 5266-1.⁵³

Figure 24: A test key

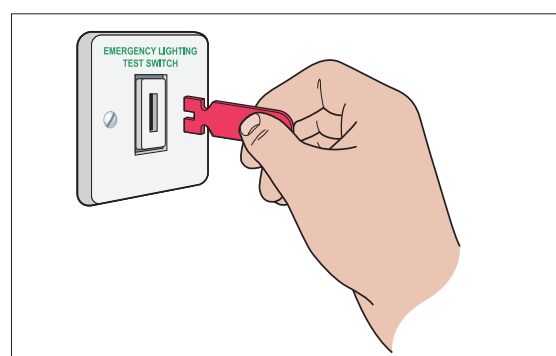

Section 6 Further guidance on signs and notices

Escape Signs

On simple sites, a few signs indicating the alternative exits might be all that is required. At more complex events or venues, a series of signs directing people along the escape routes towards the final exit may be needed.

Many people with poor vision retain some sight and are able to recognise changing or contrasting colour to provide them with visual clues when moving around a building or structure.* It may be sufficient to paint or cover any columns in a contrasting colour (see BS 8300)³⁸ and to highlight changes in level by, for example, making the nosing to step and stair treads a contrasting colour.

For people with no sight, a well managed 'buddy system', continuous handrails, a sound localisation system (which helps people to move towards an alert sound) or the installation of more tactile aids may be appropriate.

People will usually attempt to leave the event or venue by the same way that they entered. For this reason all available exits should be clearly indicated so that the public are aware that there are ways to leave the site, event or venue other than by the routes which they used to gain admission. In addition, the provision of well sign-posted exits in full view of an audience can give a feeling of security in an emergency situation.

Exit signs should be clearly visible whenever the public, staff and contractors are present.

Positioning of Escape Route Signs

The presence of other signs at the event or venue (such as advertising) can distract attention from, or obscure the visibility of escape signs. This could affect people's ability to see and understand escape signs, particularly if there is a fire evacuation. Always ensure that escape signs are not overwhelmed.

Escape signs should meet the following criteria:

- they should provide clear, unambiguous information to enable people to safely leave a building or structure in an emergency;
- every escape route sign should, where necessary, incorporate, or be accompanied by, a directional arrow. Arrows should not be used on their own;
- if the escape route to the nearest exit is not obvious then it should be indicated by a sign(s); and
- signs should be positioned so that a person escaping will always have the next escape route sign in sight.

Escape Sign Design

For a sign to comply with signs and signals regulations it must be pictographic (see figures 25 & 26). The pictogram can be supplemented by text if this is considered necessary to make the sign easily understood (BS type sign see figure 25), but you must not have a fire safety sign that uses only text. Either type of sign can be used but different types should not be mixed. Appropriate signs should take into account the needs of those who may need to use them.

The legibility of escape signs is determined by the size of the sign, its level of illumination and the distance over which it is viewed. The use of signs within the same event or venue should follow a consistent design pattern or scheme. You should not rely on a few outsized signs which may encourage people to travel to a particular escape route when other more appropriate routes should be used.

At multi-occupied events, co-operation between the respective 'responsible persons' including, if necessary, the managing agent or landlord should be sought to ensure that, as far as possible, all signs on the site conform to a single pattern or scheme.

* The Royal National Institute of the Blind estimates that only about 4% of visually impaired people are totally blind.

Figure 25: BS-type sign



Figure 26: Euro sign

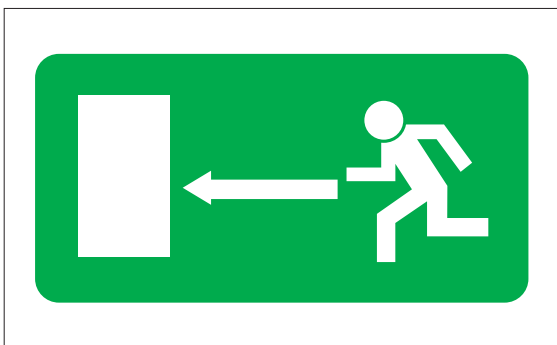

Note: Either type will be acceptable but different types should not be mixed.

Other Safety Signs and Notices

A number of other mandatory signs such as ‘Fire action’ notices may also be necessary.

Fire doors that have been fitted with self-closing devices should be labelled ‘Fire door – keep shut’ on both sides. Fire resisting doors to cupboards, stores and service ducts that are not self-closing because they are plainly kept locked should be labelled ‘Fire door – keep locked’ on the outside.

Figure 27: ‘Fire door keep shut’ notice



Signs should indicate non-automatic fire safety equipment if there is any doubt about its location, e.g. fire extinguishers that are kept in cabinets or in recesses.

A notice with the words ‘Push bar to open’ should be permanently displayed immediately above the push-bar on all doors fitted with a panic bolt or panic latch.

A notice with the words ‘Fire escape – Keep clear’ should be permanently displayed at about eye level on the external face of all doors which are provided solely as a means of escape in case of fire and which, because they are not normally used, may become obstructed.

Staff Notices

On simple sites where there is a limited number of escape routes, it may be reasonable to provide staff with reminders of what they need to do if there is a fire. You could consider providing this in a short written statement that can be delivered with staff pay slips every six months.

Where there is a high turnover of staff, a more considered approach for staff notices and instructions will be necessary. As well as positioning the fire instructions notice on escape routes adjacent to fire break-glass call points, (see Figure 28) put them where staff frequently assemble, e.g. the canteen and locker rooms.

Figure 28: A typical staff action notice

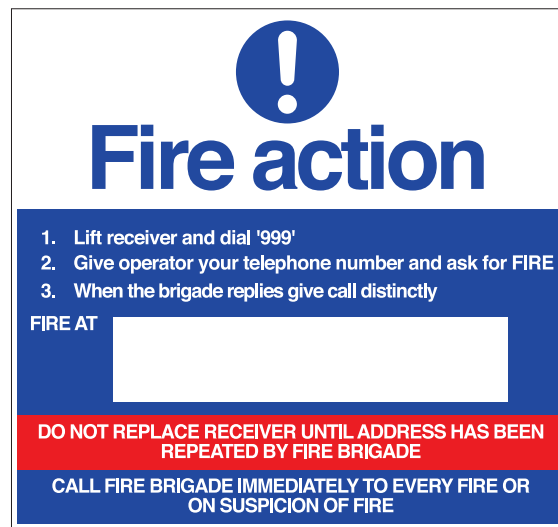

In some events or venues, such as a music festival, consider whether it is suitable for fire instruction notices to be available in public areas or whether they should only be in areas to which staff have access.

If your events or venues routinely or expected to accommodate large numbers of people whose first language is not English you may need to consider providing instruction in more than one language. The interpretation should always convey an identical message.

Illumination

All signs and notices will need illumination to ensure they are conspicuous and legible. There are a number of options available to achieve this, such as:

- external illumination;
- internal illumination; and
- self-luminescence.

The supplier or other competent person can give you further advice.

All exit and directional signs indicating the exits from any part of the event or venue to which the public are admitted should (unless they are self-luminous fire safety signs) be illuminated by means of the normal lighting and the emergency escape lighting at all times when the public are at the event or venue.

Signs or notices of the photo-luminescent type, e.g. where the active material making up the luminous parts of such signs or notices needs a period of exposure to light before they become visible in darkness (but get fainter with time) are not a substitute for appropriate emergency lighting and should only be used where other forms of illumination are present.

Further guidance

Further guidance on fire safety signs can be found in BS 5499-5⁵⁶ and BS 5499-4⁷⁷ Published guidance^{7,8} on compliance with health and safety legislation on signs is also available. Guidance about the use of photo-luminescent fire safety signs and notices can be found in BS 5266-65.⁷⁸

Section 7 Further guidance on recording, planning, informing, instructing and training

7.1 Fire safety records

Keeping up-to-date records of your fire risk assessment can help you effectively manage the fire strategy for your site and demonstrate how you are complying with fire safety law.

Even if you do not have to record the fire risk assessment, it can be helpful to keep a record of any co-operation and exchange of information made between employers and other responsible people for future reference.

At complex sites, it is best to keep a dedicated record of all maintenance of fire protection equipment and training. There is no single 'correct' format specified for this. Suitable record books are available from trade associations and may also be available from your local enforcing authority.

In all cases the quality of records may also be regarded as a good indicator of the overall quality of the fire safety management structure.

Fire safety records could include:

- a record of the sites use, means of escape, fire fighting equipment, fire alarms, and high risk areas;
- details of any significant findings from the fire risk assessment and any action taken;
- testing and checking of escape routes, including final exit locking mechanisms, such as panic bars, push pads and any electromagnetic devices;
- testing of fire-warning systems, including weekly alarm tests and periodic maintenance by a competent person;
- recording of false alarms;
- testing and maintenance of emergency escape lighting systems;
- testing and maintenance of fire extinguishers, hose reels and fire blankets etc.;
- if appropriate, testing and maintenance of other fire safety equipment such as fire suppression systems;

- training of relevant people and fire evacuation drills;
- planning, organising, policy and implementation, monitoring, audit and review;
- maintenance and audit of any systems that are provided to help the fire and rescue service; and
- the arrangements in a multi-occupied sites for a co-ordinated emergency plan or overall control of the actions you or your staff should take if there is a fire.

Other issues that you may wish to record include:

- the competence, qualifications and status of the persons responsible for carrying out inspections and tests;
- the results of periodic safety audits, reviews, inspections and tests, and any remedial action taken;
- all incidents and circumstances which had the potential to cause accidents and monitor subsequent remedial actions; and
- a record of the building or structure use, the fire prevention and protection measures in place and high-risk areas.

The range and type of records necessary will become more detailed as the site and its use becomes more complex and so the level of competence of the person carrying out the assessment will need to be higher.

Your documentation should be available for inspection by representatives of the enforcing authority.

Figure 29 shows an example record of the significant findings of a fire risk assessment. A blank version of this form is provided in Appendix B.

Figure 29: Example record of significant findings

Risk Assessment – Record of significant findings			
Risk assessment for		Assessment undertaken by	
Venue/event	Rick's music festival	Date	17 June 2006
Location	Dark Forest Old Village EF34 6WX	Completed by	R Brown
		Signature	R Brown
Sheet number	Floor/area	Use	
1	A. Main camping area B. Catering area	A. Sleeping area B. Food concessions	
Step 1 – Identify fire hazards			
Sources of ignition	Sources of fuel	Sources of oxygen	
A. Direct and radiating heat from camp fires	Fuel from camp fire, tents, caravans and vehicles, camping equipment (inc LPG), waste material, personal clothing and vegetation.	Air	
B. Hot exhaust of petrol generators	Fuel in or stored near to generator, tents, caravans and vehicles, camping equipment (inc LPG), waste material; clothing and vegetation.	Air	
Step 2 – People at risk			
A&B. 20 employees; 100 casual workers; 1000+ visitors People specially at risk A. People in the vicinity who are disabled with mobility, hearing, and visual problems; tourists (no English); mothers with young children and those asleep in tents, caravans and vehicles. B. People in mobile catering outlets and the immediate vicinity, particularly those with disabilities, eg. mobility, visual and hearing impaired visually impaired and mothers with young children.			
Step 3 – Evaluate, remove, reduce and protect from risk			
(3.1) Evaluate the risk of the fire occurring	A. Medium/high: cannot control all unauthorised camp fires. B. High: If generator sited too close to fuel and catering tent.		
(3.2) Evaluate the risk to people from a fire starting in the premises	A. Potential for fire spread to neighbouring tents, caravans and vehicles where people are sleeping. B. Potential fire spread to remainder of catering tent and contents including cooking oils, LPG cylinders and nearby vegetation (weather conditions may increase the risk).		
(3.3) Remove and reduce the hazards that may cause a fire	A. Provide safe areas for camp fires, restrict the size of fires; ensure separation distances between camp fires, tents, vehicles and caravans B. Encourage the use of alternative power; resite generators to safe distance from tent and vegetation; store spare fuel in safe area and prohibit smoking nearby.		
(3.4) Remove and reduce the risks to people from a fire	A. Ensure clear 'fire routes' through tented area; introduce regular patrols to ensure all camp fires are in designated areas or kept small and separation distances are being adhered to. B. Increase fire extinguishers in catering area; provide written guidance to concession operators; regularly patrol to ensure guidelines are being followed. A&B. Provide site wide fire warning system and communication between all stewards, with extra training to ensure early warning of fire is given. Introduce regular fire patrols to monitor hazardous activities.		
Assessment review			
Assessment review date	Completed by	Signature	
Review outcome (where substantial changes have occurred a new record sheet should be used)			

Notes:

- (1) The risk assessment record of significant findings should refer to other plans, records or other documents as necessary.
- (2) The information in this record should assist you to develop an emergency plan; coordinate measures with other 'responsible persons' at the same site or venue; and to inform and train staff and inform other relevant persons.

Fire safety audit

A fire safety audit can be used alongside your fire risk assessment to identify what fire safety provisions exist in your site, where you have a permanent open air event. When carrying out a review of your fire safety risk assessment, a pre-planned audit can quickly identify if there have been any significant changes which may affect the fire safety systems and highlight whether a full fire risk assessment is necessary.

Plans and specifications

Plans and specifications can be used to assist understanding of a fire risk assessment or emergency plan. Even where not needed for this purpose they can help you and your staff keep your fire risk assessment and emergency plan under review and help the fire and rescue service in the event of fire. Any symbols used should be shown on a key. Plans and specifications could include the following:

- essential structural features such as the layout of function rooms, escape doors, wall partitions, corridors, etc. (including any fire-resisting structure and self-closing fire doors provided to protect the escape routes);
- location of refuges that have been designated suitable for use by disabled people and others who may need assistance to escape in case of a fire;
- methods for fighting fire (details of the number, type and location of the fire fighting equipment);
- location of manually-operated fire alarm call points and control equipment for fire alarms;
- location of control rooms and steward's posts;
- location of any emergency escape lighting equipment and the exit route signs;
- location of any high-risk areas, equipment or process that must be immediately shut down by staff on hearing the fire alarm;
- location of the main electrical supply switch, the main water shut-off valve and, where appropriate, the main gas or oil shut-off valves; and
- plans and specifications relating to all recent constructions.

7.2 Emergency Plans

Your emergency should be appropriate to your event or venue. It should be kept on site and available for inspection and could include:

- how people will be warned if there is a fire;
- where people should assemble after they have left the premises and procedures for checking whether the premises have been evacuated;
- identification of key escape routes, how people can gain access to them and escape from them to a place of total safety;
- how the evacuation to a place of safety should be carried out;
- assessing the adequacy of the number of staff to supervise the evacuation;
- what training staff require and the arrangements for ensuring that this training is given;
- how the fire and rescue service, and any other necessary services, will be called and who will be responsible for doing this;
- arrangements for fighting the fire;
- information on post incident plans;
- the action to be taken by staff in the event of fire, including those who have specific fire safety functions (e.g. nominated deputies, fire marshals, etc.);
- the arrangements for any people at particular risk, for example, contractors, maintenance workers, members of the public, people with a disability;
- any specific arrangements for parts with high fire risk;
- evacuation procedures for everyone on the site, including details of escape routes;
- arrangements for calling the fire and rescue service and informing them of any special hazards.

You should include a sketch showing, where relevant:

- essential features such as the layout of the site, escape routes (including those from any structures such as a park ride or exhibit);
- the number, type and location of fire-fighting equipment available, for example extinguishers, hose reels, fire blankets;

- the location of:
 - manually-operated fire alarm call points and control equipment for the fire alarm;
 - any automatic fire-fighting system and control valve;
 - the main electrical supply point, the main water shut-off valve and (where appropriate) the main gas or oil shut-off valves; and
 - any special hazards or highly flammable substances.

For larger venues and events it is likely that the local authority and emergency services will prepare their own plan for response to a major incident at the event or venue. In these cases you will need to co-ordinate your plan with the local authority response plan so they are compatible – for example making sure that your arrangements for evacuation will not prevent the emergency services from gaining entry to the site by blocking the access route.

After the emergency plan has been prepared, prominent notices should be displayed on site giving clear instructions about what to do in case of fire. They should describe how to raise the alarm and give the location of the assembly points to which people escaping from the site should report.

On small sites, the plan can take the form of a simple fire action notice which should be posted where staff can read it and become familiar with it.

In multi-occupancy, larger and more complex events or venues, the emergency plan will need to be more detailed. It should be compiled only after consultation with other occupiers and other responsible people, e.g. owners who have control over different events within the site. In most cases this will require that an emergency plan covering the whole site/event/venue will be necessary. It will help if you can agree on one person to co-ordinate this task.

When planning an event you should consult the local fire and rescue service and consider the following issues:

- safe access in and out of the site for fire and rescue service vehicles;
- means of calling the emergency services;
- the availability of main services (particularly water for fire fighting);
- the slope or unevenness of the ground;
- impact of adverse weather conditions (such as heavy rain); and
- the availability of car parking (so that it can be properly arranged to avoid obstructing emergency access).

Your emergency plan should not be a stand alone schedule of actions to be undertaken in the event of an emergency. It should form part of your contingency planning arrangements for the variety of occurrences that may require the responsible person's attention and action during your event, which may include post fire actions. Examples of such occurrences include:

- lost children;
- animals on the loose;
- responding to crowd behaviour due to alcohol consumption;
- people with a disability;
- inclement weather;
- first aid;
- failure of sanitary arrangements;
- power failure;
- people with personal belongings (especially valuables) still in the site;
- people in a state of undress (e.g. stage performers);
- people wishing to rejoin friends; and
- getting people away from the event or venue (e.g. to transport);

Children

The particular needs of children should be considered. Parts of site used solely by children (e.g. play grounds) or where children are present require special precautions. Children should be supervised at all times. If a child care facility is provided, consideration needs to be taken of the behaviour of the parents in a fire situation, e.g. the parents first action will be locate and ensure the safety of their children. Therefore, evacuation planning should consider the parents needs to ensure the safety of the child.

Animals

People with pets, and those who have the responsibility for animal care, at venues such as a zoo, circus, and equestrian events, will have additional burdens. Special needs and legal responsibilities they may have should be accommodated prior to the open air event, so that in the event of a fire, they are clear as to the course of action they should take to ensure not only their safety, but, so far as possible, that of the animals within their care.

You should develop an action plan that considers the welfare of the animals. The necessary means for safe evacuation and the provision of holding areas, appropriate to the size and number of animals to be handled must be clearly identified. Consideration should also be given to the physical impacts and dangers of animals on the escape of the occupants. Bedding materials are a considerable fire risk. Any potential ignition sources such as heating or lighting should be controlled and the location/storage of such materials must be assessed to ensure that adequate animal and people safety is achieved. You should organise this in advance.

Crowd behaviour

Research has highlighted several important factors, which influence the way crowds behave. Although some of these factors are not directly related to fire safety, crowd behaviour may affect the types of precautions you put in place to ensure fire safety and need to be considered during your event planning.

People who are unfamiliar with the event or venue generally require more assistance and direction. Their tendencies are to follow the crowds, use main routes and gather at the same accommodation areas, which can lead to an uneven distribution of people. Control the entry numbers or number of people within specific areas and try to prevent migration or overcrowding which may create a greater risk to their safety than a fire.

They may be unaware of the location of emergency exits causing them to use those routes or exits with which they are familiar or which are the most obvious, rather than those, which are closest or give the quickest evacuation time. You can improve site familiarity by the use of high visibility signage and printing site details on the back of tickets. In addition, consider the use screens in the

arena (where provided) for safety announcements and indicating the positions of exit routes.

You should also consider how to communicate this information with multiple nationalities and people with a disability (e.g. visually impaired persons).

Prior expectations are likely to have a significant impact upon people's reactions under certain circumstances:

- Visitors might regard some routes and entry points as the 'formal' or main access to the event. Perhaps such a route is the most direct between the parking area and the part of the venue that they want to visit. It might be wider and resemble the main route with adjacent facilities such as toilets and stalls.
- Where smoke or similar effects are part of an event (e.g. a fireworks display, dry ice effects at a pop concert), people are likely to respond more slowly to the presence of smoke generated by a fire hazard.

The behaviour of individuals in a crowd can be influenced by the things they see others doing. The unauthorised actions of a few people can result in larger numbers following their example. Individuals within a crowd may carry out actions, which they would not perform if they were on their own. For example, the frustration of excessive crowding, queuing or delays may result in incidents such as climbing of barriers, which could lead to overcrowding in another area.

In general, people look for clear, unambiguous information and indicators on expected rules of behaviour to help them decide how to act, e.g. to find out if a particular route is an entrance, an exit, or both, or whether they can drink or smoke. If such information and instructions are not provided, people will form their own rules based on past experience joining a queue, parking on access routes or taking short cuts. Good use of signs and public address systems is therefore extremely important. People are more likely to be in a relaxed and contented frame of mind if they are effectively managed and the event is comfortable and pleasant.

Guidance on developing health and safety management policy has been published by the HSE.⁵⁷

7.3 Information, instruction, co-operation and co-ordination

Supplying information

You must provide easily understandable information for employees and others working at the venue or event about the measures in place to ensure a safe escape from the site and how they will operate, for example:

- any significant risks to staff and others that have been identified in your fire risk assessment or any similar assessment carried out by another user and responsible person on the site;
- the fire prevention and protection measures and procedures on your site and where they impact on staff and others on the site;
- the procedures for fighting a fire on the site; and
- the identity of people who have been nominated with specific responsibilities on your site.

Even if you do not have to record the fire risk assessment, it would be helpful to keep a record of any co-operation and exchange of information made between employers and other responsible people for future reference.

You need to ensure that all staff and, where necessary, others who work at the event or venue, receive written information given in a way that can be easily understood. This might include any special instructions to particular people who have been allocated a specific task, such as shutting down equipment or guiding people to the nearest safe exit.

Duties of employees to give information

Employees also have a duty to take reasonable care for their own safety and that of other people who may be affected by their activities. This includes the need for them to inform their employer of any activity that they consider would present a serious and immediate danger to their own safety and that of others.

Dangerous substances

HSE publishes guidance¹⁴ about specific substances where appropriate information may need to be provided. If any of these, or any other substance that is not included but nevertheless presents more than a slight risk, is present on site then you must provide such information to staff and others, specifically you must:

- provide the name of the substance and the risks associated with it, e.g. how to safely use or store the product to avoid creating highly flammable vapours or explosive atmospheres;
- identify any legislative provisions that may be associated with the substance;
- allow employees access to the hazardous substances safety data sheet; and
- inform the local fire and rescue service where dangerous substances are present on the site.

Information to the emergency services

In the case where the assessment identifies a risk and it is not possible to reduce it enough, then you should communicate the findings to the emergency services to enable them to prepare their own response procedures.

It will also be helpful to provide information to the emergency services, for instance, on the temporary loss of a fire-fighting facility.

Procedures should also include meeting and briefing the Fire and Rescue Service when they arrive.

Instruction

The responsible person for each individual unique, occasional or separate event or function will need to be clearly established and documented. It is crucial that the responsible person understands their duties for the duration of the event or function. The responsible person will need to take account of the layout of the event and the fire safety provisions within the site.

As the responsible person for the event/function, you have legal duties with regards to the safety of those persons assisting or attending the event. You will need to carefully consider the type of instructions to staff and other people working at your event or venue. Written instructions must be concise, comprehensible and relevant and therefore must be reviewed and updated as new working practices and hazardous substances are introduced.

Inclusive access and employment policies mean that people with learning difficulties may now be present in a range of events at your venue and your fire risk assessment should consider whether further instruction or guidance is necessary to ensure that your

evacuation strategy is appropriate and understood by everyone.

Instructions will need to be given to people delegated to carry out particular tasks, for example:

- removing additional security, bolts, bars or chains on final exit before the start of the event / opening for business to ensure that escape routes are accessible;
- daily, weekly, monthly, quarterly and yearly checks on the range of fire safety measures (at some events or venues the work may be contracted out to a specialist company);
- safety considerations when closing down the event or venue at the end of the day, e.g. removing rubbish, ensuring enough exits are available for people that remain;
- leaving hazardous substances in a safe condition when evacuating the event or venue;
- safe storage of hazardous substances at all material times.

Specific instructions may be needed about:

- how a fire will be detected and people warned;
- your arrangements for fighting fire;
- your arrangements for the safe evacuation of people, including those identified as being especially at risk, such as those with disabilities, children, those caring for animals;
- sweeping' of the event or venue by staff to guide people to the nearest safe exit when the fire alarm sounds;
- designating particular areas of your event or venue to check that no one remains inside;
- who will be responsible for calling the fire and rescue service and any other necessary services;
- taking charge at the assembly area;
- meeting and directing fire and rescue service vehicles and appliances;
- cover arrangements when nominated people are not present, on leave or sick;
- who will stop any technical equipment/ power supplies that need to be stopped or isolated if there is a fire;

- how you will proceed if the life safety systems you have and are out of order, e.g. fire detection, emergency lighting and alarm systems;
- who will meet the fire and rescue service and other emergency services on their arrival and notifying them of any special risks, e.g. the location of highly flammable materials;
- where people should assemble after they have left an event and procedures for checking whether the event or venue has been evacuated; and
- your plans to deal with people once they have left the site, especially children.

Co-operation and co-ordination

Where you share an event or venue with others (this includes people who are self-employed or in partnership), each responsible person, e.g. each employer, owner or other person who has control over any part of the event or venue, will need to co-operate and co-ordinate the findings of their separate fire risk assessments to ensure the fire precautions and protection measures are effective throughout the event or venue.

This could include:

- co-ordinating an emergency plan (see Part 1 Step 4.2 and Part 2 Section 7.2 for the features of an emergency plan);
- identifying the nature of any risks and how they may affect others in or about the event or venue;
- identifying any fire prevention and protection measures;
- identifying any measures to mitigate the effects of a fire;
- arranging any necessary contacts with external emergency services; and
- arrangement for calling the emergency services if an emergency occurs.

Responsibilities for short term leasing

Premises or other facilities may be leased or hired from their owner (e.g. temporary structures and marquees). The fire safety responsibilities of those leasing parts of the event or venue (and, hence, in charge of the activities conducted within the building or structure), and those of the owner/lessee, need to be established as part of the contract of hire.

At some events or venues (e.g. music concerts), part of the event may be hired out to another organisation for a separate function (e.g. product launch). The fire safety responsibilities of those organising the separate function, and those of the remainder of the building, need to be established as part of the contract of hire.

7.4 Fire safety training

Staff training

The actions of staff in the event of a fire are likely to be crucial to their safety and that of other people at the event or venue. All staff should receive basic fire safety induction training and attend refresher sessions at pre-determined intervals.

You should ensure that all staff and contractors are told about the emergency plan and are shown the escape routes.

The training should take account of the findings of the fire risk assessment and be easily understood by all those attending. It should include the role that those members of staff will be expected to carry out if a fire occurs.

In addition to the guidance given in Part 1, Step 4.4, as a minimum all staff should receive instruction on:

- the items listed in your emergency plan, including the correct action to be taken when a fire is discovered and the evacuations and escape arrangements – especially assisting disabled persons and others with special needs;
- the importance of basic fire-prevention measures;
- where relevant, the appropriate use of fire-fighting equipment;
- the importance of reporting to the assembly area;
- exit routes and the operation of exit devices, including physically walking these routes; and
- general matters such as permitted smoking areas or restrictions on cooking other than in designated areas.

Training is necessary:

- when staff start employment or are transferred to the event or venue;
- when changes have been made to the emergency plan and the preventative and protective measures;
- where working practices and processes or people's responsibilities change;
- to take account of any changed risks to the safety of staff or other relevant persons;
- to ensure that staff know what they have to do to safeguard themselves and others at the event or venue;
- if the member of staff may take on the role of "duty manager".

Training should be repeated as often as necessary and should take place during working hours.

Whatever training you decide is necessary to support your fire safety strategy and emergency plan, it should be verifiable and supported by management.

Enforcing authorities may want to examine records as evidence that adequate training has been given.

Where safety personnel from an outside agency are on duty, it is your responsibility to ensure that such personnel have been trained to carry out the duties and responsibilities assigned to them.

Individuals who do not form a recognised part of the safety management structure (such as some security guards, hospitality staff, ground staff and commissionaires) should not be counted among the safety staff. You should ensure that such staff are given a general safety briefing on the means of escape, evacuations procedures and safety equipment.

Fire marshals

Staff expected to undertake the role of fire marshals (often called fire wardens), will require more comprehensive training. Their role may include:

- helping members of the public or visitors leave the event or venue;
- checking designated areas to ensure everyone has left;

- using fire-fighting equipment if safe to do so;
- liaising with the fire service on arrival;
- shutting down vital or dangerous equipment; and
- performing a supervisory/managing role in any fire situation.

Training for this role may include:

- detailed knowledge of the fire safety strategy of the event or venue;
- a basic understanding of human behaviour in fires;
- how to encourage others to use the most appropriate escape route;
- how to search safely and recognise areas that are unsafe to enter;
- the difficulties that some people, particularly people with a disability, may have in escaping and any special evacuation arrangements that have been pre-planned;
- additional training in the use of fire-fighting equipment;
- reporting of faults, incidents and near misses.

For licensed events or venues, entry supervisors may have a fire safety function and appropriate training should be provided.

Volunteers

It is not uncommon for a considerable number of people, including the responsible person undertaking the majority of tasks at an open air event, to be volunteers. Even though they are to carry out duties or services for which they are receiving no remuneration, for the purposes of the Order¹ they are employees and hence people at risk.

If you are the responsible person for safety you should ensure that all volunteers receive the appropriate training, instruction and direction on actions to be taken in the event of an emergency.

If your event is conducted over a number of consecutive days and you have a high turnover of volunteers, you must ensure that you give new volunteers the appropriate training and instruction.

Any people who work at the venue should be aware of any evacuation procedures, fire-fighting equipment, and associated management procedures to adopt in the event of a fire. This should be outlined to them by their direct employer and/or supervisor.

Fire Drills

Once the emergency plan has been developed and training given, you will need to evaluate its effectiveness. The best way to do this at permanent venues is to perform a practice fire evacuation. This should be carried out at least annually or as determined by your fire risk assessment. If your venue contains large numbers of people, you should carefully consider the risk of practice evacuations, due to slips, trips and falls or crushing. If you have a high staff turnover, you may need to carry them out more often. At temporary events the fire emergency plan may need to be audited, so that where a practice evacuation is impractical, the effectiveness of the plan is ascertained.

A well-planned and executed fire evacuation will confirm understanding of the training and provide helpful information for future training. The responsible person should determine the possible objectives of the practice evacuation such as to:

- identify any weaknesses in the evacuation strategy;
- test the procedure following any recent alteration or changes to working practices;
- familiarise new members of staff/volunteers with procedures;
- test the arrangements for disabled people; and
- 'spot check' staff knowledge with appropriate questions on procedures.

Who should take part?

Within each venue the evacuation should include all occupants except those who may need to ensure the security of the venue, or people who, on a risk-assessed basis, are required to remain with particular equipment or processes that cannot be closed down. However, it is not expected that you will carry out a practice evacuation of the public during a short term, or one off, event such as a fete or music festival.

Carrying out the practice evacuation

For venues that have more than one escape route, the escape plan should be designed to evacuate all people on the assumption that one escape route is unavailable because of the fire. Applying this scenario to different escape routes at each practice evacuation will encourage individuals to use alternative escape routes which they may not normally use.

When carrying out the practice evacuation you might find it helpful to:

- circulate details concerning the evacuation and inform all staff of their duty to participate. It may not be beneficial to have 'surprise evacuations' as the health and safety risks introduced may outweigh the benefits;
- ensure that equipment can be safely left;
- nominate observers;
- inform the alarm receiving centre if the fire-warning system is monitored. (If the fire and rescue service is normally called directly from your venue, ensure that this does not happen);
- inform members of the public if they are present;
- ask a member of staff at random to set off the alarm by operating the nearest alarm call point using the test key. This will indicate the level of knowledge regarding the location of the nearest call point; and
- block an exit, preferably the main site entry, to ensure that you test staff responses and procedures effectively.

More detailed information on practice evacuations and test evacuations are given in BS5588-12³⁹, The Event Safety Guide¹⁰ and The Guide to Safety at Sports Grounds.¹¹

Monitoring and debrief

Throughout the drill the responsible person and nominated observers should pay particular attention to:

- any communication difficulties when establishing that the event or venue has been evacuated and that everyone is accounted for;
- the use of the nearest available escape routes as opposed to common circulation routes;
- difficulties experienced by people with a disability or others with special needs (including difficulties in evacuating or the time taken to evacuate);
- the roles of specified people, e.g. fire wardens; and
- inappropriate actions, e.g. stopping to collect personal items.

On-the-spot debriefs are useful to discuss the practice evacuation, encouraging feedback from everybody. Later, reports from fire wardens and observations from people should be collated and reviewed. Any conclusions and remedial actions should be recorded and implemented.

Section 8 Quality assurance of fire protection equipment and installation

Fire protection products and related services should be fit for their purpose and properly installed and maintained in accordance with the manufacturer's instructions or a relevant standard.

Third-party certification schemes for fire protection products and related services are an effective means of providing the fullest possible assurances, offering a level of quality, reliability and safety that non-certificated products may lack. This does not mean goods and services that are not third-party approved are less reliable, but there is no obvious way in which this can be demonstrated.

Third-party quality assurance can offer comfort, both as a means of satisfying you that the goods and services you have purchased are fit for purpose, and as a means of demonstrating that you have complied with the law.

However, to ensure the level of assurance offered by third party schemes, you should always check whether the company you employ sub-contracts work to others. If they do, you will want to check that the sub-contractors are subject to the level of checks of quality and competence as the company you are employing.

Your local fire and rescue service, fire trade associations or your own trade association may be able to provide further details about third party quality assurance schemes and the various organisations that administer them.

Appendix A

Example fire safety maintenance checklist

As a starting point in formulating your fire safety policy, this sample fire safety checklist can be used for any event or venue that does not have complex fire safety measures. It should not be used as a substitute for carrying out a full fire risk assessment.

You can modify the example where necessary to fit your venue/event and may need to incorporate the recommendations of manufacturers and installers of the fire safety equipment/systems that you may have installed at your event or venue.

Any ticks in the grey boxes should result in further investigation and appropriate action as necessary. At complex events and venues you may need to seek the assistance of a competent person to carry out some of the checks.

You must tailor the checklist to suit your individual event and expand or reduce the conditions and provisions as appropriate.

	Yes	No	N/A	Comments
Pre Event Checks – Summary				
Escape routes	<input type="checkbox"/>	<input type="checkbox"/>	<input type="checkbox"/>	
Escape routes and Emergency lighting	<input type="checkbox"/>	<input type="checkbox"/>	<input type="checkbox"/>	
Signs and Notices	<input type="checkbox"/>	<input type="checkbox"/>	<input type="checkbox"/>	
Fire detection installation	<input type="checkbox"/>	<input type="checkbox"/>	<input type="checkbox"/>	
Means of warning	<input type="checkbox"/>	<input type="checkbox"/>	<input type="checkbox"/>	
Back up power supplies	<input type="checkbox"/>	<input type="checkbox"/>	<input type="checkbox"/>	
Firefighting equipment	<input type="checkbox"/>	<input type="checkbox"/>	<input type="checkbox"/>	
Emergency vehicles access routes	<input type="checkbox"/>	<input type="checkbox"/>	<input type="checkbox"/>	
Assembly points	<input type="checkbox"/>	<input type="checkbox"/>	<input type="checkbox"/>	
Communication system	<input type="checkbox"/>	<input type="checkbox"/>	<input type="checkbox"/>	

Note: This pre event checks should only be a summary record of the checks detailed in the following pages, undertaken as relevant to the type and duration of the event (e.g. for short events, monthly and three monthly checks may all be relevant)

General				
Is there an identified testing/maintenance system?	<input type="checkbox"/>	<input type="checkbox"/>	<input type="checkbox"/>	
Is there a recording system?	<input type="checkbox"/>	<input type="checkbox"/>	<input type="checkbox"/>	

	Yes	No	N/A	Comments
Daily checks (not normally recorded)				
Escape routes				
Can all fire exits be opened immediately and easily?	<input type="checkbox"/>	<input type="checkbox"/>	<input type="checkbox"/>	
Are escape routes clear?	<input type="checkbox"/>	<input type="checkbox"/>	<input type="checkbox"/>	
Fire warning systems				
Do you have systems for warning persons in the event of fire?	<input type="checkbox"/>	<input type="checkbox"/>	<input type="checkbox"/>	
Are whistles, gongs or air horns in place?	<input type="checkbox"/>	<input type="checkbox"/>	<input type="checkbox"/>	
Is the indicator panel showing 'normal'?	<input type="checkbox"/>	<input type="checkbox"/>	<input type="checkbox"/>	
Have you taken action to minimise false alarms?	<input type="checkbox"/>	<input type="checkbox"/>	<input type="checkbox"/>	
Escape lighting				
Are luminaires and exit signs in good condition and undamaged?	<input type="checkbox"/>	<input type="checkbox"/>	<input type="checkbox"/>	
Firefighting equipment				
Are all fire extinguishers in place?	<input type="checkbox"/>	<input type="checkbox"/>	<input type="checkbox"/>	
Are fire extinguishers clearly visible?	<input type="checkbox"/>	<input type="checkbox"/>	<input type="checkbox"/>	
Weekly checks				
Escape routes				
Do all emergency fastening devices to fire exits (push bars and pads, etc.) work correctly?	<input type="checkbox"/>	<input type="checkbox"/>	<input type="checkbox"/>	
Are external routes clear and safe?	<input type="checkbox"/>	<input type="checkbox"/>	<input type="checkbox"/>	
Fire warning systems				
Did the alarm system work correctly when tested?	<input type="checkbox"/>	<input type="checkbox"/>	<input type="checkbox"/>	
Did staff and other people hear the fire alarm?	<input type="checkbox"/>	<input type="checkbox"/>	<input type="checkbox"/>	
Did any linked fire protection systems operate correctly? (e.g. gas supply shutdown)	<input type="checkbox"/>	<input type="checkbox"/>	<input type="checkbox"/>	
Do all visual alarms and/or vibrating alarms and pagers (as applicable) work?	<input type="checkbox"/>	<input type="checkbox"/>	<input type="checkbox"/>	
Do voice alarm systems work correctly? Was the message understood?	<input type="checkbox"/>	<input type="checkbox"/>	<input type="checkbox"/>	
Escape lighting				
Are charging indicators (if fitted) visible?	<input type="checkbox"/>	<input type="checkbox"/>	<input type="checkbox"/>	
Does generator start correctly?	<input type="checkbox"/>	<input type="checkbox"/>	<input type="checkbox"/>	
Firefighting equipment				
Is all equipment in good condition?	<input type="checkbox"/>	<input type="checkbox"/>	<input type="checkbox"/>	
Additional items from manufacturer's recommendations.	<input type="checkbox"/>	<input type="checkbox"/>	<input type="checkbox"/>	
Monthly checks				
General				
Have all your emergency generators been tested? (Normally run for one hour)	<input type="checkbox"/>	<input type="checkbox"/>	<input type="checkbox"/>	
Escape routes				
Do all electronic release mechanisms on escape doors work correctly? Do they 'fail safe' in the open position?	<input type="checkbox"/>	<input type="checkbox"/>	<input type="checkbox"/>	

	Yes	No	N/A	Comments
Monthly checks (continued)				
Emergency escape lighting				
Do all luminaires and exit signs function correctly when tested?	<input type="checkbox"/>	<input type="checkbox"/>	<input type="checkbox"/>	
Firefighting equipment				
Is the pressure in 'stored pressure' fire extinguishers correct?	<input type="checkbox"/>	<input type="checkbox"/>	<input type="checkbox"/>	
Additional items from manufacturer's recommendations.	<input type="checkbox"/>	<input type="checkbox"/>	<input type="checkbox"/>	
Three-monthly checks				
General				
Are any emergency water tanks/ponds at their normal capacity?	<input type="checkbox"/>	<input type="checkbox"/>	<input type="checkbox"/>	
Are vehicles blocking fire hydrants or access to them?	<input type="checkbox"/>	<input type="checkbox"/>	<input type="checkbox"/>	
Additional items from manufacturer's recommendations.	<input type="checkbox"/>	<input type="checkbox"/>	<input type="checkbox"/>	
Six-monthly checks				
General				
Has staff training been carried out?	<input type="checkbox"/>	<input type="checkbox"/>	<input type="checkbox"/>	
Has a fire evacuation drill been carried out preferably every six months, but at least annually?	<input type="checkbox"/>	<input type="checkbox"/>	<input type="checkbox"/>	
Has any sprinkler system been tested by a competent person?	<input type="checkbox"/>	<input type="checkbox"/>	<input type="checkbox"/>	
Have the release and closing mechanisms of any fire-resisting compartment doors and shutters been tested?	<input type="checkbox"/>	<input type="checkbox"/>	<input type="checkbox"/>	
Fire warning system				
Has the system been checked by a competent person?	<input type="checkbox"/>	<input type="checkbox"/>	<input type="checkbox"/>	
Escape lighting				
Do all luminaires operate on test for one third of their rated value?	<input type="checkbox"/>	<input type="checkbox"/>	<input type="checkbox"/>	
Additional items from manufacturer's recommendations.	<input type="checkbox"/>	<input type="checkbox"/>	<input type="checkbox"/>	
Annual checks				
General				
Has staff training been carried out?	<input type="checkbox"/>	<input type="checkbox"/>	<input type="checkbox"/>	
Escape routes				
Have escape routes been suitably maintained?	<input type="checkbox"/>	<input type="checkbox"/>	<input type="checkbox"/>	
Emergency escape lighting				
Do all luminaires operate on test for their full rated duration?	<input type="checkbox"/>	<input type="checkbox"/>	<input type="checkbox"/>	
Has the system been thoroughly checked by a competent person?	<input type="checkbox"/>	<input type="checkbox"/>	<input type="checkbox"/>	
Firefighting equipment				
Has all firefighting equipment been checked by a competent person?	<input type="checkbox"/>	<input type="checkbox"/>	<input type="checkbox"/>	
Miscellaneous				
Has external access for the fire and rescue service been checked?	<input type="checkbox"/>	<input type="checkbox"/>	<input type="checkbox"/>	
Have any firefighters' switches been tested?	<input type="checkbox"/>	<input type="checkbox"/>	<input type="checkbox"/>	
Are fire engine direction signs in place?	<input type="checkbox"/>	<input type="checkbox"/>	<input type="checkbox"/>	

Appendix B

Example record of significant findings

Figure 30: Example record of significant findings

Risk Assessment – Record of significant findings		
Risk assessment for		Assessment undertaken by
Venue/event		Date
Location		Completed by
		Signature
Sheet number	Floor/area	Use
Step 1 – Identify fire hazards		
Sources of ignition	Sources of fuel	Sources of oxygen
Step 2 – People at risk		
Step 3 – Evaluate, remove, reduce and protect from risk		
(3.1) Evaluate the risk of the fire occurring		
(3.2) Evaluate the risk to people from a fire starting in the premises		
(3.3) Remove and reduce the hazards that may cause a fire		
(3.4) Remove and reduce the risks to people from a fire		
Assessment review		
Assessment review date	Completed by	Signature
Review outcome (where substantial changes have occurred a new record sheet should be used)		

Notes:

- (1) The risk assessment record of significant findings should refer to other plans, records or other documents as necessary.
- (2) The information in this record should assist you to develop an emergency plan; coordinate measures with other 'responsible persons' at the event or venue; and to inform and train staff and inform other relevant persons.

Appendix C

Technical information on fire-resisting separation, fire doors and door fastenings

C1 Fire-resisting separation

General

The majority of temporary buildings are constructed from materials that are thin, light weight, flexible in use, easy to erect have little or no fire resistance. In these cases it would be unusual to provide fire resisting separation inside such structures. However, there are instances however where more rigid building forms, such as portakabins, will be used. In these instances, there may be a requirement to provide some formal fire separation in the building. The following guidance on fire separation is intended for this building type as they are likely to contain a higher hazard than a marquee but it could be used elsewhere if required.

The materials from which this type of structure is constructed may determine the speed with which a fire may spread, affecting the escape routes that people will use. A fire starting in a building constructed mainly from readily combustible material will spread faster than one where modern fire-resisting construction materials have been used. Where non-combustible materials are used and the internal partitions are made from fire-resisting materials,

the fire will be contained for a longer period, allowing more time for the occupants to escape.

You will need to consider whether the standard of fire resistance and surface finishing in the escape routes is satisfactory, has been affected by wear and tear or alterations and whether any improvements are necessary.

The following paragraphs give basic information on how fire-resisting construction can provide up to 30 minutes protection to escape routes. This is the standard recommended for most situations. If you are still unsure of the level of fire resistance which is necessary after reading this information, you should consult a fire safety expert.

Fire-resisting construction

The fire resistance of a wall or floor is dependent on the quality of construction and materials used. Common examples of types of construction that provide 30 minute fire resistance to escape routes if constructed to the above standards are:

- internal framed construction wall, non-load bearing, consisting of 72mm x 37mm timber studs at 600mm centres and faced with 12.5mm of plasterboard with all joints taped and filled (see Figure 35); and
- internal framed construction, non-load bearing, consisting of channel section steel studs at 600mm centres faced with 12.5mm of plasterboard with all joints taped and filled.

Figure 31: Fire-resisting construction

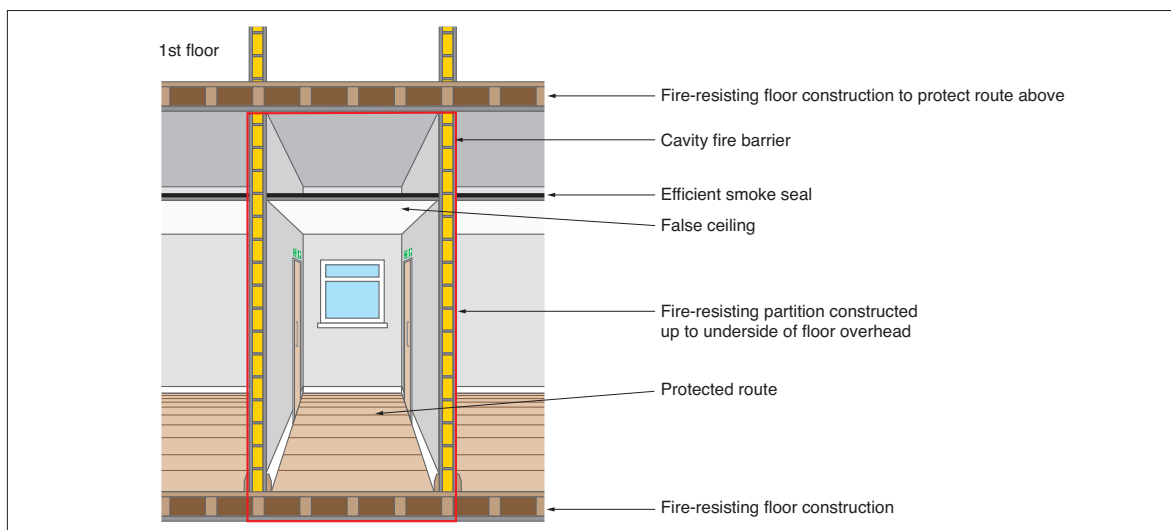

There are other methods and products available which will achieve the required standard of fire resistance and may be more appropriate for the existing construction in premises. If there is any doubt about how your building is constructed, then ask for further advice from a competent person.

Fire-resisting floors

The fire resistance of floors will depend on the existing floor construction as well as the type of ceiling finish beneath.

A typical example of a 30-minute fire-resisting timber floor is tongue and groove softwood of not less than 15mm finished thickness on 37mm timber joists, with a ceiling below of one layer of plasterboard to a thickness of 12.5mm with joints taped and filled and backed by supporting timber.

There are other, equally valid, methods and products available for upgrading floors. If you are in any doubt you should ask the advice of a competent person and ensure that the product is installed in accordance with instructions from the manufacturer or supplier.

Fire-resisting glazing

The most common type of fire-resisting glazing is 6mm Georgian wired glazing, which is easily identifiable. Clear fire-resisting glazing is available and can quickly be identified by a mark etched into the glass, usually in the corner of the glazed panel, to confirm its fire-resisting standard. Although this is not compulsory, the marking of glass is supported by the Glass and Glazing Federation; you should check whether the glazing will be marked accordingly before purchase. The glazing should have been installed in accordance with the manufacturer's instructions and to the appropriate standard, to ensure that its fire-resisting properties are maintained.

The performance of glazed systems in terms of fire resistance and external fire exposure should, wherever possible, be confirmed by test evidence. Alternatively, where there is a lack of test information, ask for an assessment of the proposed construction from suitably qualified people.

Fire separation of voids

A common problem encountered with fire separation is fire-resisting partitions which do not extend above false ceilings to true ceiling height. This may result in unseen fire spread

and a loss of vital protection to the escape routes. It is important therefore to carefully check all such partitions have been installed correctly.

Breaching fire separation

To ensure effective protection against fire, walls and floors providing fire separation must form a complete barrier, with an equivalent level of fire resistance provided to any openings such as doors, ventilation ducts, or pipe passages.

The passing of services such as heating pipes or electrical cables through fire-resisting partitions leaves gaps through which fire and smoke may spread. This should be rectified by suitable fire stopping and there are many proprietary products available to suit particular types of construction. Such products should be installed by competent contractors.

Décor and surface finishes of walls, ceilings and escape routes

The materials used to line walls and ceilings can contribute significantly to the spread of flame across their surface. Most materials that are used as surface linings will fall into one of three classes of surface spread of flame.

The following are common examples of acceptable materials for various situations:

Class 0: Materials suitable for circulation spaces and escape routes

Such materials include ceramic tiles, plaster finishes (including rendering), wood-wool cement slabs and mineral fibre tiles or sheets with cement or resin binding.

Note: Additional finishes to these surfaces may be detrimental to the fire performance of the surface and if there is any doubt about this then consult the manufacturer of the finish.

Class 1: Materials suitable for use in all rooms but not on escape routes

Such materials include all the Class 0 materials referred to above. Additionally, timber, hardboard, blockboard, particle board, heavy flock wallpapers and thermosetting plastics will be suitable if flame-retardant treated to achieve a Class 1 standard.

Class 3: Materials suitable for use in rooms of less than 30m²

Such materials include all those referred to in Class 1, including those that have not been

flame-retardant treated and certain dense timber or plywood and standard glass-reinforced polyesters.

The equivalent European classification standard will also be acceptable. Further details about internal linings and classifications are available in Approved Document B.⁸⁸ Appropriate testing procedures are detailed in BS 476-7⁵⁸ and where appropriate BS EN 13501-1.⁵⁹

Further guidance on types of fire-resisting construction has been published by the Building Research Establishment.⁶⁰

C2 Fire-resisting doors

Requirements of a fire-resisting door

Effective fire-resisting doors are vital to ensure that the occupants can evacuate to a place of safety. Correctly specified and well-fitted doors will hold back fire and smoke, preventing escape routes becoming unusable, as well as preventing the fire spreading from one area to another.

Fire-resisting doors are necessary in any doorway located in a fire-resisting structure. Most internal doors are constructed of timber. These will give some limited protection against fire spread, but only a purpose-built fire-resisting door that has been tested to an approved standard will provide the necessary protection.

All fire-resisting doors are rated by their performance when tested to an appropriate standard. The level of protection provided by the door is measured, primarily by determining the time taken for a fire to breach the integrity (E), of the door assembly, together with its resistance to the passage of hot gases and flame.

Timber fire-resisting doors require a gap of 2-4mm between the door leaf and the frame.

However larger gaps may be necessary to ensure that the door closes flush into its frame when smoke seals are fitted. Further information is available in BS 4787-1.⁶¹ For fire-resisting purposes the gap is normally protected by installing an intumescent seal, in either the door or, preferably, the frame.

The intumescent seal expands in the early stages of a fire and enhances the protection given by the door.

Additional smoke seals either incorporated in the intumescent seal or fitted separately will restrict the spread of smoke at ambient temperatures. Doors fitted with smoke seals, either incorporated in the intumescent seal or fitted separately, have their classification code suffixed with a 'S'.

The principal fire-resisting door categories are:

- E20 fire-resisting door providing 20 minutes fire resistance (or equivalent FD 20S). (Note: Many suppliers no longer provide an E20 type fire-resisting door.)
- E30 fire-resisting door providing 30 minutes fire resistance (or equivalent FD 30S).
- E60 fire-resisting door providing 60 minutes fire resistance (or equivalent FD 60S).

Timber fire-resisting doors are available that will provide up to 120 minutes fire resistance but their use is limited to more specialised conditions that are beyond the scope of this guidance.

Glazing in fire-resisting doors

Although glazing provides additional safety in everyday use and can enhance the appearance of fire-resisting doors, it should never reduce the fire resistance of the door. The opening provided in the door for the fire-resisting glazing unit(s) and the fitting of the beading are critical, and should only be entrusted to a competent person. In nearly all cases the door and glazing should be purchased from a reputable supplier who can provide documentary evidence that the door continues to achieve the required rating.

Fire-resisting door furniture

Hinges

To ensure compliance with their rated fire performance, fire-resisting doors must to be hung with the correct number, size and quality of hinges. Normally a minimum of three hinges are needed, however the manufacturer's instructions should be closely followed. BS EN 1935⁸³ including Annex B, is the appropriate standard.

Alternative door mountings

Although the most common method of hanging a door is to use single axis hinges, alternative methods are employed where the door is required to be double swing or mounted on pivots for other reasons.

Floor mounted controlled door closing devices are the most common method regularly found with timber, glass and steel doors while transom mounted devices are commonly used with aluminium sections. In each case reference should be made to the fire test report for details as to compliance with the composition of the door assembly including the door mounting conditions.

Self-closing devices

All fire-resisting doors, other than those to locked cupboards and service ducts, should be fitted with an appropriately controlled self closing device that will effectively close the door from any angle. In certain circumstances,

concealed, jamb-mounted closing devices may be specified and in these cases should be capable of closing the door from any angle and against any latch fitted to the door; spring hinges are unlikely to be suitable. Further information is available in BS EN 1154.⁶³

Rising butt hinges are not suitable for use as a self-closing device due to their inability to close and latch the door from any angle.

Installation and workmanship

The reliability and performance of correctly specified fire-resisting doors can be undermined by inadequate installation. It is important that installers with the necessary level of skill and knowledge are used. Accreditation schemes for installers of fire-resisting doors are available.

Fire-resisting doors and shutters will require routine maintenance, particularly to closing mechanisms.

Figure 32: A fire door with smoke seals and infumescent strips

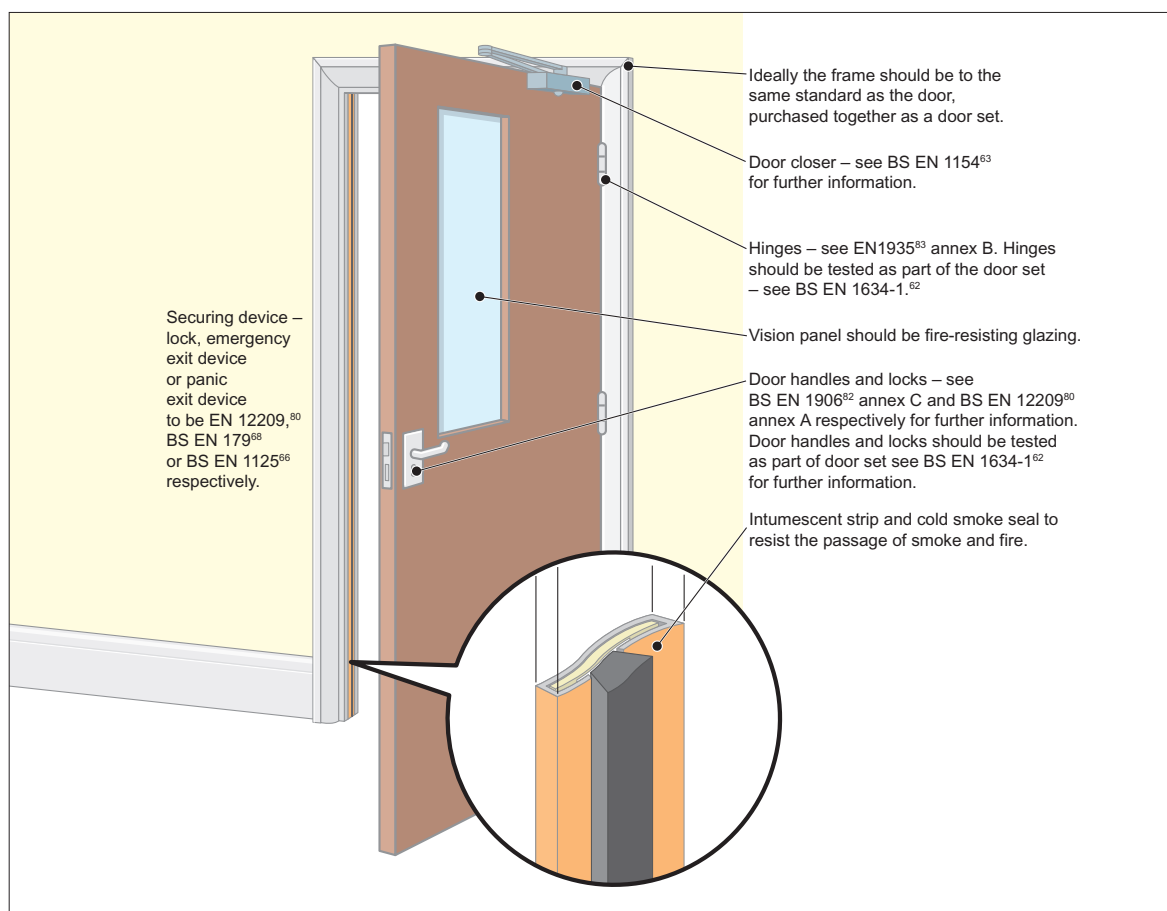

Further information on fire-resisting doors is available in BS 8214⁶⁴. If you are unsure about the quality, the effectiveness or the fitting of your fire-resisting doors consult a fire safety expert. For further guidance on the selection and maintenance of door furniture suitable for use on timber fire resisting and escape doors refer to Building Hardware Industry Federation (BHIF) Code of Practice – Hardware for Timber Fire and Escape Doors⁶⁷.

C3 Door-fastening devices

The relationship between the securing of doors against unwanted entry and the ability to escape through them easily in an emergency has often proved problematical. Careful planning and the use of quality materials remain the most effective means of satisfying both of these objectives.

Any device that impedes people making good their escape, either by being unnecessarily complicated to manipulate or not being readily openable, will not be acceptable.

Guidance on fire exits starts from the position that doors on escape routes should not be fitted with any locking devices. However, it is accepted that in many cases the need for security will require some form of device that prevents unlimited access, but still enables the occupants of a building or area to open the door easily if there is a fire. These devices can take many forms but, in the majority of cases, premises where there are members of the public present or others who are not familiar with the building should use panic exit bar devices, (i.e. push bars or touch bars). See BS EN 1125⁶⁶ for further information.

Premises that have limited numbers of staff or others who are familiar with the building and where panic is not likely may use alternative devices, (i.e. push pads or lever handles). See BS EN 179⁶⁸ for further information.

When only staff are on the premises and there is a security issue, it may be acceptable to restrict the number of emergency exits immediately available, e.g. when only security staff are present at night or prior to opening to the public in the morning. Staff should be made fully aware of any restrictions and the number of exits not immediately available should be limited.

Appendix D

Glossary

These definitions are provided to assist the responsible person in understanding some of the technical terms used in this guide. They are not exhaustive and more precise definitions may be available in other guidance.

Term	Definition
Alterations notice	If your site, event or venue are considered by the enforcing authority to be high risk, they may issue an alterations notice that requires you to inform them before making any material alterations to your site, event or venue.
Alternative escape route	Escape routes sufficiently separated by either direction and space, or by fire-resisting construction to ensure that one is still available irrespective of the location of a fire.
As low as reasonably practicable	Is a concept where risks should continue to be reduced until you reach a point where the cost and effort to reduce the risk further would be grossly disproportionate to the benefit achieved.
Automatic fire-detection system	A means of automatically detecting the products of a fire and sending a signal to a fire warning system. The design and installation should conform to BS 5839.18 ⁸⁹ See 'Fire warning'.
Automatic fire-suppression system	A means of automatically suppressing or extinguishing a fire.
Child	Anyone who is not over compulsory school age, e.g. before or just after their 16th birthday.
Competent person	A person with enough training and experience or knowledge and other qualities to enable them properly to assist in undertaking the preventative and protective measures.
Dangerous substance	<p>1. A substance which because of its physico-chemical or chemical properties and the way it is used or is present at the workplace creates a risk.</p> <p>2. A substance subject to the Dangerous Substances and Explosive Atmosphere Regulations 2002 (DSEAR).¹³</p>
Dead end	Area from which escape is possible in one direction only.
Emergency escape lighting	Lighting provided to illuminate escape routes that will function if the normal lighting fails.
Enforcing authority	The Fire and Rescue Authority or any other Authority specified in Article 25 of the Regulatory Reform (Fire Safety) Order 2005. ¹

Term	Definition
Escape route	Route forming that part of the means of escape from any point in a site, event or venue to a final exit.
False alarm	Is a concept where risks should continue to be reduced until you reach a point where the cost and effort to reduce the risk further would be grossly disproportionate to the benefit achieved.
Final exit	An exit from a site, event or venue where people can continue to disperse in safety and where they are no longer at danger from fire and/or smoke.
Fire Emergency Plan	A written operation methodology, forming part of the overall Emergency Plan, to be implemented as applicable in the event of a fire.
Fire door	A door or shutter, together with its frame and furniture, provided for the passage of people, air or goods which, when closed is intended to restrict the passage of fire and/or smoke to a predictable level of performance.
Fire resistance	The ability of a component or construction of a building to satisfy, for a stated period of time, some or all of the appropriate criteria of BS EN 1363-1, ²⁰ BS 476-7 ⁵⁸ and associated standards. (Generally described as 30 minutes fire resisting or 60 minutes fire resisting.)
Fire safety manager	A nominated person with responsibility for carrying out day-to-day management of fire safety. (This may or may not be the same as the 'responsible person'.)
Fire safety strategy	A number of planned and co-ordinated arrangements designed to reduce the risk of fire and to ensure the safety of people if there is a fire.
Fire stopping	A seal provided to close an imperfection of fit or design tolerance between elements or components, to restrict the passage of fire and smoke.
Fire-warning system	A means of alerting people to the existence of a fire. (See automatic fire detection system.)
Hazardous substance	1. See Dangerous substance. 2. A substance subject to the Control of Substances Hazardous to Health Regulations 2002 (COSHH).
Highly flammable	Generally liquids with a flashpoint of below 21°C. (The Chemicals (Hazard Information and Packaging for Supply Regulations 2002 ⁷⁰ (CHIP) give more detailed guidance.)
Licensed premises	Any site, event or venue that require a license under any statute to undertake trade or conduct business activities.
Maintained lighting	Emergency lighting that is kept illuminated at all relevant times.

Term	Definition
Material change	An alteration to a building, process or service which significantly affects the level of risk in that building.
Means of escape	Route(s) provided to ensure safe egress from a site, event or venue or other locations to a place of total safety.
Phased evacuation	A system of evacuation in which different parts of the site, event or venue are evacuated in a controlled sequence of phases, those parts of the site, event or venue expected to be at greatest risk being evacuated first.
Place of reasonable safety	A place within a site, event or venue where, for a limited period of time, people will have some protection from the effects of fire and smoke. This place must allow people to continue their escape to a place of total safety.
Place of total safety	A place, away from the site, event or venue, in which people are at no immediate danger from the effects of a fire.
Premises	Any place (including the open air), such as a building and the immediate land bounded by any enclosure of it, any tent, moveable or temporary structure or any installation or workplace.
Refuge	An area of reasonable safety in which a disabled person may rest before reaching a place of total safety. It should lead directly to a fire-resisting escape route.
Responsible person	The person ultimately responsible for fire safety as defined in the Regulatory Reform (Fire Safety) Order 2005.
Significant finding	<p>A feature of the site, event or venue, from which the fire hazards and persons at risk are identified.</p> <p>The actions you have taken or will take to remove or reduce the chance of a fire occurring or the spread of fire and smoke.</p> <p>The actions people need to take in case of fire.</p> <p>The necessary information, instruction and training needed and how it will be given.</p>
Smoke alarm	Device containing within one housing all the components, except possibly the energy source, for detecting smoke and giving an audible alarm.
Staged fire alarms	A fire warning which can be given in two or more stages for different purposes within a given area (i.e. notifying staff, stand by to evacuate, full evacuation).
Travel distance	The actual distance to be travelled by a person from any point within the floor area to the nearest storey exit or final exit, having regard to the layout of wall, partitions and fixings.

Term	Definition
Where necessary	<p>The Order requires that fire precautions (such as firefighting equipment, fire detection and warning, and emergency routes and exits) should be provided (and maintained) 'where necessary'.</p> <p>What this means is that the fire precautions you must provide (and maintain) are those which are needed to reasonably protect relevant person from risks to them in case of fire. This will be determined by the finding of your risk assessment including the preventative measures you have or will have taken. In practice, it is very unlikely, that a properly conducted fire risk assessment, which takes into account all the matters relevant for the safety of persons in case of fire, will conclude that no fire precautions (including maintenance) are necessary.</p>
Young persons	<p>(a) A person aged 16 years, from the date on which he attains that age until and including the 31st August which next follows that date.</p> <p>(b) A person aged 16 years and over who is undertaking a course of full-time education at a school or college which is not advanced education.</p> <p>(c) A person aged 16 years and over who is undertaking approved training that is not provided through a contract of employment.</p> <p>For the purposes of paragraphs (b) and (c) the person:</p> <p>(a) shall have commenced the course of full-time education or approved training before attaining the age of 19 years: and</p> <p>(b) shall not have attained the age of 20 years.</p>

References

- 1 Regulatory Reform (Fire Safety) Order 2005 SI 2005/1541. The Stationery Office, 2005. ISBN 0 11 072945 5.
- 2 The Building Regulations 2000 SI 2000/2531. ISBN 0 11 099897 9.
- 3 Fire Precautions Act 1971 (c 40). The Stationery Office, 1971. ISBN 0 10 544071 X.
- 4 Fire Precautions (Workplace) Regulations 1997 SI 1997/1840. The Stationery Office, 1997. ISBN 0 11 064738 6.
- 5 Fire Precautions (Workplace) (Amendment) Regulations 1999 SI 1999/1877. The Stationery Office 1999. ISBN 0 11 082882 8.
- 6 Licensing Act 2003, The Stationary Office. ISBN 0 10 541703 3.
- 7 Health and Safety (Safety Signs and Signals) Regulations 1996 SI 1996/341. The Stationery Office, 1996. ISBN 0 11 054093 X.
- 8 *Safety signs and signals. The Health and Safety (Safety Signs and Signals) Regulations 1996. Guidance on regulations*, L64. HSE Books, 1996. ISBN 0 7176 0870 0.
- 9 Office of the Deputy Prime Minister – Fire Statistics, United Kingdom 2003, ODPM Publications, ISBN 1 85112 775 5.
- 10 HSG 195 – The Event Safety Guide: Health and Safety Commission / Home office / The Scottish Office 1993.
- 11 Guide to Safety at Sports Grounds. Department of National Heritage/The Scottish Office Fourth Edition 1997. ISBN 0 11 300095 2.
- 12 Guide to Health Safety and Welfare at Pop Concerts and Similar Events. Health and Safety Commission/ Home Office/ The Scottish Office, 1993 (now renamed as The Event Safety Guide – see ref. 10)
- 13 Dangerous Substances and Explosive Atmospheres Regulations 2002 SI 2002/2776. The Stationery Office, 2002. ISBN 0 11 042957 5.
- 14 *Dangerous Substances and Explosive Atmospheres. Dangerous Substances and Explosive Atmospheres Regulations 2002. Approved Code of Practice and guidance* L138. HSE Books, 2003. ISBN 0 7176 2203 7.
- 15 *Storage of full and empty LPG cylinders and cartridges. Code of practice 7*. LP Gas Association, 2000. Available from LP Gas Association, Pavilion 16, Headlands Business Park, Salisbury Road, Ringwood, Hampshire BH24 3PB.
- 16 *Maintaining portable electrical equipment in offices and other low-risk environments* Leaflet INDG236 HSE Books 1996 (single copy free or priced packs of 10 ISBN 0 7176 1272 4).
- 17 Construction (Health, Safety and Welfare) Regulations 1996 SI 1996/1592. The Stationery Office, 1996. ISBN 0 11 035904 6.
- 18 *A guide to the Construction (Health, Safety and Welfare) Regulations 1996* Leaflet INDG220. HSE Books, 1996. (Single copy free or priced packs of 10 ISBN 0 7176 1161 2).
- 19 *Health and safety in construction* HSG 150 (Second edition). HSE Books, 2001. ISBN 0 7176 2106 5.
- 20 BS EN 1363-1: *Fire resistance tests. General requirements*. British Standards Institution Chemicals (Hazard Information and Packaging for Supply Regulations 2002 SI 2002/1689. The Stationery Office, 2002. ISBN 0 11 042419 0.
- 21 The Management of Health and Safety at Work Regulations 1999. The Stationery Office.
- 22 The Fireworks Regulations 2004 (SI 2004 No. 1836) amended by SI2004 No. 3262.
- 23 Explosives Act 1875.
- 24 Control of Explosions Regulations 1991. Statutory Instrument 1991. No. 1531.
- 25 HSG 123 – Working together on firework displays.
- 26 HSE Information sheet “Smoke and vapour effects used in entertainment; Entertainment Sheet No. 3. Health and Safety Executive. HSE Books.

- 27 Code of practice for pyrotechnics and smoke effects, Association of British Theatre Technicians.
- 28 The Electricity at Work Regulations 1989. The Stationery Office. Statutory Instrument 1989 No. 635.
- 29 The Electrical Equipment (Safety) Regulations 1994. The Stationery Office. Statutory Instrument 1994 No. 3260.
- 30 Temporary demountable structures: Guidance on design, procurement and use. Institution of Structural Engineers.
- 31 BS 7837: *Specification for the flammability performance for textiles used in the construction of marquees and similar textile structures*. British Standards Institution. ISBN 0 580 24953 0.
- 32 BS 6661: 1986 *Guide for the design, construction and maintenance of single-skin air supported structures*. British Standards Institution.
- 33 The Furniture and Furnishings (Fire) (Safety) Regulations 1988. The Stationery Office, ISBN 0110873246.
- 34 The Furniture and Furnishings (Fire) (Safety) (Amendment) Regulations 1989. The Stationery Office. ISBN 0110983580.
- 35 BS 5867:2 *Specification for fabrics for curtains and drapes. Flammability requirements*. British Standards Institution.
- 36 BS 1892: Part 3 :2003 *Gymnasium equipment. Sports mats. Specification for fire safety requirements for mats, mattresses and landing areas*. British Standards Institution.
- 37 Disability Discrimination Act 1995 (c 50) The Stationery Office 1995 ISBN 0 10 545095 2
- 38 BS 8300: *The design of buildings and their approaches to meet the needs of disabled people. Code of practice* British Standards Institution. ISBN 0 580 38438 1
- 39 BS5588-12: *Fire Precautions in the design, construction and use of buildings – Part 12: Managing fire safety*. British Standards Institution. ISBN 0 580 44586 0.
- 40 ODPM/CACFOA/BFPSA Guidance on reducing false alarms.
- 41 BS 5839: *Fire Detection and alarm systems for buildings Part 2: Specification for manual call points*.
- 42 BS 5839-1: *Fire detection and alarm systems for buildings. Code of practice for system design, installation, commissioning and maintenance*. British Standards Institution. ISBN 0 580 40376 9.
- 43 BS 5839: *Fire Detection and alarm systems for buildings Part 8: Code of practice for the design, installation and servicing of voice alarms*. British Standards Institution. ISBN 0 580 40376 9.
- 44 BS EN 60849:1998 *Sound systems for emergency purposes*. British Standards Institution.
- 45 BS 5306-8: 2000 *Fire extinguishing installations and equipment on premises. Selection and installation of portable fire extinguishers. Code of practice*. British Standards Institution. ISBN 0 580 33203 9.
- 46 Manual Handling Operations Regulations 1992 SI 1992/2793. The Stationery Office, 1992. ISBN 0 11 025920 3.
- 47 BS 5306-3: *Fire extinguishing installations and equipment on premises. Code of practice for the inspection and maintenance of portable fire extinguishers*. British Standards Institution. ISBN 0 5808 42865 6.
- 48 BS EN 3-7: *Portable fire extinguishers. Characteristics, performance requirements and testing*. British Standards Institution.
- 49 BS 5306-8: 2000 *Fire extinguishing installations and equipment on premises. Selection and installation of portable fire extinguishers*. British Standards Institution. ISBN 0 580 33203 9.
- 50 BS 7863: 1996 *Recommendations for colour coding to indicate the extinguishing media contained in portable fire extinguishers*. British Standards Institution. ISBN 0 580 25845 9.
- 51 Workplace (Health, Safety and Welfare) Regulations 1992 SI 1992/3004. The Stationery Office, 1992. ISBN 0 11 025804 5.
- 52 BS 5266-8: *Emergency lighting. Code of practice for Emergency Escape lighting systems*. British Standards Institution.

- 53 BS 5266-1: *Emergency lighting. Code of practice for the emergency lighting of premises other than cinemas and certain other specified premises used for entertainment*. British Standards Institution.
- 54 BS EN 1838: *Lighting applications. Emergency lighting*. British Standards Institution. ISBN 0 580 329925.
- 55 BS 5499: Part 1: *Graphical symbols and signs specification for geometric shapes, colours and layouts*. British Standards Institution. ISBN 0 580 38258 3.
- 56 BS 5499-5: *Graphical symbols and signs. Safety signs, including fire safety signs. Signs with specific safety meanings*. British Standards Institution.
- 57 Successful health and safety management HSG 65 (Second edition). HSE Books, 1997. ISBN 0 7176 1276 7.
- 58 BS 476- 7: *Fire tests on building materials and structures. Method of test to determine the classification of the surface spread of flame of products*. British Standards Institution.
- 59 BS EN 13501-1 *Fire classification of construction products and building elements. Classification using test data from reaction to fire tests*. British Standards Institution.
- 60 Guidelines for the construction of fire resisting structural elements. Building Research Establishment Report BR 128, 1988.
- 61 BS 4787-1 *Internal and external wood doorsets, door leaves and frames. Specification for dimensional requirements*. British Standards Institution.
- 62 BS EN 1634-1: *Fire resistance tests for door and shutter assemblies. Fire doors and shutters*. British Standards Institution. ISBN 0 580 32429 X.
- 63 BS EN 1154 *Building hardware. Controlled door closing devices. Requirements and test methods*. British Standards Institution. ISBN 0 580 27476 4.
- 64 BS 8214 *Code of practice for fire door assemblies with non-metallic leaves*. British Standards Institution. ISBN 0 580 18871 6.
- 65 BS 476-22: 1987 *Fire tests on building materials and structures. Methods for determination of the fire resistance of non-loadbearing elements of construction*. British Standards Institution. ISBN 0 580 15872 1.
- 66 BS EN 1125: *Building hardware. Panic exit devices operated by a horizontal bar. Requirements and test methods*. British Standards Institution. ISBN 0 580 28863 3.
- 67 *Hardware for Timber fire and escape doors*. BHIF 2000.
- 68 BS EN 179: *Building hardware. Emergency exit devices operated by a lever handle or push pad. Requirements and test methods*. British Standards Institution. ISBN 0 580 28863 3.
- 69 BS 8220: *Guide for security of buildings against crime. Offices and shops*. British Standards Institution. ISBN 0 580 23692 7.
- 70 Chemicals (Hazard Information and Packaging for Supply) Regulations 2002, SI 2002/1689. The Stationery Office, 2002. ISBN 0 11 042419 0.
- 71 The Construction (Design and Management) Regulations 1994. CONDAM/CDM Regs. HMSO, 1994.
- 72 BS 5588 Part 6: *Fire precautions in the design construction and use of buildings. Code of practice for places of assembly*. British Standards Institution.
- 73 Construction Information Sheet No 51 'Construction Fire Safety'. Health and Safety Executive.
- 74 HSG 168: *Fire safety in construction work* (ISBN 0-7176-1332-1). Health and Safety Executive.
- 75 'Fire prevention on construction sites – The joint code of practice on the protection from fire of construction sites and buildings undergoing renovation' Fifth edition. London: Fire Protection Association and Construction Federation, 2000 (ISBN 0-90216739-1).
- 76 BS 5588-8: *Fire precautions in the design, construction and use of buildings. Code of practice for means of escape for disabled people*. British Standards Institution. ISBN 28267 7.
- 77 BS 5499-4: *Safety signs, including fire safety signs. Code of practice for escape route signing*. British Standards Institution.
- 78 BS 5266-6: *Emergency lighting. Code of practice for non-electrical mounted way guidance systems for emergency use. Photo luminescent system systems*. British Standards Institution.

- 79 BS 5588-12: *Fire precautions in the design, construction and use of buildings – Part 12: Managing fire safety*. British Standards Institution.
- 80 BS EN 12209: *Building hardware, locks and latches. Mechanically operated locks, latches and locking plate*. British Standards Institution.
- 81 BS EN 1155: *Building hardware. Electrically powered hold open devices for swing doors. Requirements and test methods*. British Standards Institution.
- 82 BS EN 1906: *Building hardware. Lever handles and knob furniture. Requirements and test methods*. British Standards Institution.
- 83 BS EN 1935: *Building hardware. Single axis hinges. Requirements and test methods*. British Standards Institution. ISBN 0 580 39272 4.
- 84 BS EN 1634 – 2: *Fire resistance tests and shutter assemblies. Part 2, fire door hardware. Building hardware for fire-resisting doorsets and openable windows*. British Standards Institution.
- 85 Local Government (miscellaneous Provisions) Act 1982 (c30). The stationery Office, 1982. ISBN0 10543082 x.
- 86 The Building Regulations 1991: Approved Document M access and use of buildings (2004 edition).
- 87 BS EN 671-3: *Fixed firefighting systems. Hose systems. Maintenance of hose reels with semi-rigid hose and hose systems with lay-flat hose*. British Standards Institution. ISBN 0 580 34112 7.
- 88 *The Building Regulations 2000: Approved Document B Fire Safety*. The Stationery Office. ISBN 0 11753911 2.
- 89 BS 5839-3: *Fire detection and alarm systems for buildings. Specification for automatic release mechanisms for certain fire protection equipment*. British Standards Institution. ISBN 0 580 15787 3.
- 90 Safety of Sports Ground Act 1975, HMSO

Further reading

The latest versions of all documents listed in this section should be used, including any amendments.

Any views expressed in these documents are not necessarily those of the Communities and Local Government.

BS 4422	Fire. Vocabulary. British Standards Institution.
BS PD 6512-3	Use of elements of structural fire protection with particular reference to the recommendations given in BS 5588 <i>Fire precautions in the design and construction of buildings</i> . Guide to the fire performance of glass. British Standards Institution.
BS EN 81	Safety rules for the construction and installation of lifts. British Standards Institution.
BS EN 81-70	Safety rules for the construction and installation of lifts. Particular applications for passenger and goods passenger lifts. Accessibility to lifts for persons including persons with disability. British Standards Institution.
BS 5041-1	Fire hydrant systems equipment. Specification for landing valves for wet risers. British Standards Institution.
BS 5041-2	Fire hydrant systems equipment. Specification for landing valves for dry risers. British Standards Institution.
BS 5041-3	Fire hydrant systems equipment. Specification for inlet breechings for dry riser inlets. British Standards Institution.
BS 5041-4	Fire hydrant systems equipment. Specification for boxes for landing valves for dry risers. British Standards Institution.
BS 5041-5	Fire hydrant systems equipment. Specification for boxes for foam inlets and dry riser inlets. British Standards Institution.
BS 9990	Code of practice for non-automatic firefighting systems in buildings. British Standards Institution.
BS 7944	Type 1 heavy duty fire blankets and type 2 heavy duty heat protective blankets. British Standards Institution.
BS EN 1869	Fire blankets. British Standards Institution.
BS ISO 14520-1	Gaseous fire-extinguishing systems. Physical properties and system design. General requirements. British Standards Institution.
BS 5266-2	Emergency lighting. Code of practice for electrical low mounted way guidance systems for emergency use. British Standards Institution.
BS EN 60598-1	Luminaires. General requirements and tests. British Standards Institution.

BS 5499-1	Graphical symbols and signs. Safety signs, including fire safety signs. Specification for geometric shapes, colours and layout. British Standards Institution.
BS EN 1634-3	Fire resistance tests for door and shutter assemblies. Smoke control doors and shutters. British Standards Institution.
Draft BS EN 14637	Building hardware. Electrically controlled hold-open systems for fire/smoke door assemblies. Requirements, test methods, application and maintenance. (Consultation document.) British Standards Institution.
BS EN 45020	Standardisation and related activities. General vocabulary. British Standards Institution.
ISO 13784-2	Reaction to fire tests for sandwich panel building systems. Part 2: test method for large rooms. British Standards Institution.
BS 6661	Guide for design, construction and maintenance of single-skin air supported structures.
BS 5268-4.2	Structural use of timber. Fire resistance of timber structures. Recommendations for calculating fire resistance of timber stud walls and joisted floor constructions. British Standards Institution.

Management of Health and Safety at Work Regulations 1999, SI 1999/3242.

Design principles of fire safety. The Stationery Office, 1996. ISBN 0 11 753045 X.

Chemicals (Hazard Information and Packaging for Supply) Regulations 2002, SI 2002/1689. The Stationery Office, 2002. ISBN 0 11 042419 0. Supporting guides: *The idiot's guide to CHIP 3: Chemicals (Hazard Information and Packaging for Supply) Regulations, 2002*, INDG350. HSE Books, 2002. ISBN 0 7176 2333 5 (single copy free or priced packs of 5); *CHIP for everyone*, HSG228. HSE Books, 2002. ISBN 0 7176 2370 X.

Guidance on the acceptance of electronic locks to doors required for means of escape. Published by The Chief and Assistant Chief Fire Officers' Association.

Ensuring best practice for passive fire protection in buildings. Building Research Establishment, 2003. ISBN 1 870409 19 1.

Smoke shafts protecting fire shafts: their performance and design, BRE Project Report 79204. Building Research Establishment, 2002.

Fire safety of PTFE-based material used in building, BRE Report 274. Building Research Establishment, 1994. ISBN 0 851256 53 8.

Fires and human behaviour. David Fulton Publishers, 2000. ISBN 1 85346 105 9.

Management of health and safety at work. Management of Health and Safety at Work Regulations 1999. Approved code of practice and guidance, L21 (second edition). HSE Books, 2000. ISBN 0 7176 2488 9.

Index

Page numbers in italics refer to information in Figures or Tables.

A

access for firefighters 24, 25, 33, 60, 61, 65, 86, 94, 96
 aerosols 67
 air-supported structures 4, 52
 alarms *see* fire detection and warning systems
 alterations 9, 12, 40, 50, 57, 105
 alterations notices 6, 9, 12, 34, 41, 50, 103
 animals 15, 17, 23, 36–7, 86, 87, 89
 arenas 45, 76, 87
 arson 14, 18, 20, 21, 44, 45, 53
 assembly points 26, 29, 39, 56, 65, 85, 86, 89, 90, 94
 automatic fire detection systems 22, 23, 47, 50, 55, 56, 70, 103

B

barbecues 14, 17, 20, 67
 building work 9, 41, 50

C

camp fires 14, 20, 84
 camping areas 11, 23, 24, 61, 66, 84
 candles 14, 20
 catering facilities 8, 14, 16, 20, 24, 46, 48, 51, 53, 60, 64, 84
 escape routes 67
 cavity barriers 66, 98
 ceilings
 fire-resisting 66, 98, 99
 lining materials 99–100
 children 6, 7, 17, 37, 77, 84, 86, 103, 106
 evacuating 26, 54, 67, 89
 circuses 11, 64, 87
 close down procedures 39, 85, 89
 co-operation and co-ordination 6, 7, 37, 38, 83, 86, 89
 competent persons 4, 6, 7, 12–13, 83, 103
 dangerous substances 46
 electrical safety 49
 emergency escape lighting 82, 96
 equipment and machinery 48
 escape routes 66, 73
 fire detection and warning systems 56, 57, 96
 fire-resisting separation 99
 firefighting equipment and facilities 31, 32, 60, 62, 96
 concessions 12, 19, 64, 67, 77, 84
 conduction, fire spreading by 18

construction, fire-resisting 45, 51, 65–6, 67, 70, 77, 85, 98–100, 104
 contingency plans 86
 contractors
 certifying 31, 33, 93
 fire safety training 7, 37, 38, 90
 managing 50
 permit to work 50
 risk to 16, 23, 85
 source of ignition 50
 convection, fire spreading by 18
 cooking 14, 20, 48, 49, 59, 64, 90
 crowd control 26, 67, 86, 87

D

dangerous substances 20, 21, 45–7, 89
 dead ends
 escape routes 65–6, 70, 74, 75, 103
 fire alarms 56
 decorations 15, 45, 51
 disability *see* people with special needs
 Disability Discrimination Act 1995 53
 display materials 14, 15, 20, 45, 51
 doors
 door-fastenings 65, 83, 89, 95, 96, 101, 102
 door furniture 100–1
 final exit 65, 76, 83
 fire-resisting 51, 66, 81, 85, 96, 100–2, 104
 glazing 100
 maintenance 31, 32, 96, 101
 metal 101
 notices 81
 revolving 75
 self-closing 81, 85, 101
 shutters 51, 75, 96, 101, 104
 sliding 75
 vision panels 100, 101
 wicket 75

E

electrical safety 14, 15, 17, 20, 45, 46, 49, 64, 85
 emergency escape lighting 29–30, 33, 46, 78–9, 82, 85, 89, 103, 104
 auxiliary power supply 30, 78, 79, 95
 non-electric 79
 self-contained 78
 tests, checks and maintenance 7, 31, 32, 79, 83, 94, 95, 96
 torches 29, 32

emergency plans 23, 34, 36–7, 40, 43, 65, 67, 83, 85–7, 89, 90, 104
 equipment and machinery 14, 17, 20, 32, 33, 39, 47–8, 64, 85, 89, 92
 escape routes 25–8
 alternative exits 73, 74, 75, 80, 103
 corridors 85
 dead ends 65–6, 70, 74, 75, 103
 emergency lighting 29–30, 33, 46, 78–9, 82, 85, 89, 103, 104
 escape time 27, 29, 63, 64, 68–70
 final exits 65, 76, 83, 104
 gangways 65, 67, 68, 76–7
 gates 26, 27, 28, 29, 63, 65, 68, 76, 77
 inner rooms 70, 72
 layouts 22, 25, 29, 85
 levels of risk 63–5, 68–70
 maintenance 7, 25, 31, 32, 96
 managing 28
 number required 26, 27–8, 29, 33, 65, 67
 obstructions 19, 28, 32, 44, 48, 65, 67, 76, 95
 people with special needs 25, 53–4, 67, 80
 ramps 65, 67, 68
 signs and notices 26, 30, 31, 33, 65, 78, 80–2, 85, 87
 suitability 65
 tests and checks 32, 33, 38, 83, 94, 95
 training 38, 39, 90, 91–2
 travel distance 22, 27, 56, 63, 64–5, 70–1, 72, 74, 75, 105
 type and number of people using premises 22, 26, 27, 29, 40, 54, 64, 66–7, 68–70, 72, 75, 87
 widths and capacity of 26, 27, 29, 63, 65, 67–70
 see also doors; gangways
 evacuation
 to central area of activity 77
 fire drills 39, 40, 83, 91–2, 96
 managed 28, 56–7
 phased 23, 56–7, 105
 strategy 22, 39, 53–4, 63–5, 67, 85–6, 89
The Event Safety Guide 27, 43, 47, 52, 53, 69, 71, 92
 explosives 47
 extinguishers 24, 25, 31, 32, 38, 58–60, 81, 83, 84, 85, 95, 96

F
 fairgrounds 4, 11, 15, 16, 40
 false alarms 56, 57, 83, 95, 104
 fences 10, 19, 26, 32, 45
 festivals 4, 19, 43, 82, 84
 fêtes 34, 63, 64, 91
 fire
 classes of 24, 58–9
 examples of fires 10, 11
 spread of 12, 18–19, 34, 51–3, 64, 77, 99

fire blankets 24, 60, 83, 85
 fire certificates 5, 8
 fire dampers 66
 fire detection and warning systems 22–3, 33, 55–7, 84, 85, 89, 104
 alarm receiving centre 92
 automatic fire detection systems 22, 23, 47, 50, 55, 56, 70, 103
 auxiliary power supply 57, 94
 false alarms 56, 57, 83, 95, 104
 manual call points 22, 55–6, 79, 86, 92
 monitoring 53, 55, 85, 92, 95
 phased evacuation 23, 56–7
 quality assurance 93
 record-keeping 32, 34, 57, 83
 smoke detectors 72, 105
 sound levels 55, 95
 staff alarms 56
 staged alarms 56–7, 105
 tests and checks 7, 31, 32, 33, 34, 57, 83, 92, 94, 95
 visual alarms 55, 95
 voice alarms 56, 95
 fire drills 39, 40, 83, 91–2, 96
 fire marshals 24, 85, 90–1, 92
 fire points 60
 fire-resisting separation 51, 98–100
 fire risk assessment
 aims 11
 co-operation and co-ordination 6, 7, 37, 38, 83, 86, 89
 emergency plans 23, 34, 36–7, 40, 43, 65, 67, 83, 85–7, 89, 90, 104
 evaluating risk 11, 12, 13, 17–19, 33, 50, 63–5, 68–70, 84
 Fire Safety Order and 5–9, 11, 12, 62, 91, 103, 105, 106
 flexibility 22, 65
 identifying fire hazards 11, 13, 15, 34, 84, 97
 identifying people at risk 13, 16–17, 34, 63–5, 68–70, 84, 85, 97
 information and instruction 6, 7, 26, 28, 30–1, 34, 37–8, 56, 60, 61, 80–2, 84, 86, 87, 88–9
 method 12–13
 plan of action 43, 53–4, 83, 87
 record-keeping 6, 8, 12, 13, 16, 32, 34–6, 38, 83, 84, 97
 removing or reducing fire hazards 11, 19–21, 33, 34, 41, 43, 53, 84, 97
 removing or reducing risk to people 34, 43, 53, 97
 reviewing 9, 13, 40–1, 50, 83, 84, 85, 97
 sources of fuel 11, 14, 15–16, 20–1, 28, 33, 44–7, 51–3, 64, 84
 sources of ignition 11, 14–15, 16, 17–18, 20, 28, 33, 44, 46, 47–50, 53, 64, 84
 sources of oxygen 14, 16, 21, 33, 45, 84

fire safety audit 83, 85, 91
 fire safety management 10, 28, 43, 57, 104
 Fire Safety Order 5–9, 11, 12, 62, 91, 103, 105, 106
 fire safety planning 10, 83
 fire safety strategy 39, 67, 104
 fire stopping 51, 66, 99, 104
 fire suppression systems 83
 automatic 86, 96, 103
 firefighters' switches 61, 62, 96
 firefighting equipment and facilities 23–5, 33, 85
 access for firefighters 24, 25, 33, 60, 61, 65, 86, 94, 96
 extinguishers 24, 25, 31, 32, 38, 58–60, 81, 83, 84, 85, 95, 96
 fire blankets 24, 60, 83, 85
 fire points 60
 fire pumps 32, 62
 firefighters' switches 61, 62, 96
 firefighting lifts and shafts 25
 hose reels 32, 60, 83, 85
 hydrants 24, 31, 58, 62, 96
 information to emergency services 88, 89, 91
 maintenance 7, 25, 31, 32, 34, 59–60, 62, 83, 96
 outdoor protection for 24
 quality assurance 93
 record-keeping 32, 34, 83
 signs 24, 25, 30, 31, 62, 81, 96
 standpipes 60
 tests and checks 25, 32, 33, 59–60, 94, 95, 96
 training 24, 38, 39, 58, 90, 91
 see also fire suppression systems
 fireworks 14, 15, 16, 20, 21, 45, 47
 flame-retardant materials 20, 45, 51–2, 98, 99–100
 flame tests 53
 flammable liquids 15, 20, 45, 46, 53, 58, 59, 104
 flares 14, 20, 47
 floors
 covering materials 15, 52, 77
 fire-resisting 52, 98, 99
 foam, fire risk of 15, 52
 fuel, sources of 11, 14, 15–16, 20–1, 28, 33, 44–7, 51–3, 64, 84
 furniture and furnishings 15, 20, 52
 see also seating

G
 gangways 65, 67, 68, 76–7
 gas cylinders 16, 21, 46, 64, 67
 see also LPG
 gates 26, 27, 28, 29, 63, 65, 68, 76, 77
 generators 14, 15, 20, 32, 48, 60, 62, 64, 78, 79, 84, 95
 glass, fire-resisting 99, 100
 grass fires 15, 19, 21, 50
The Guide to Safety at Sports Grounds 6, 27, 43, 65, 68, 69, 76, 77, 92

H

hazard
 definition 11
 identifying fire hazards 11, 13, 15, 34, 64, 84, 97
 removing or reducing 11, 19–21, 33, 34, 41, 43, 53, 84, 97
 hazardous materials 5, 19, 20, 40, 46–7, 88, 89, 104
 Health and Safety Executive (HSE) 5, 8, 12, 47, 49, 50, 87, 88
 heating 14, 20, 48, 87
 hose reels 32, 60, 83, 85
 hospitality areas 8, 16, 19
 housekeeping 39, 44

I

ignition, sources of 11, 14–15, 16, 17–18, 20, 28, 33, 44, 46, 47–50, 53, 64, 84
 information and instruction 6, 7, 26, 28, 30–1, 34, 37–8, 56, 60, 61, 80–2, 84, 86, 87, 88–9

L

leased premises 8, 89–90
 licensed premises 6, 12, 34, 36, 76, 91, 104
 lifts, firefighting 25
 lighting 14, 17, 45, 46, 49, 79, 82, 87
 lightning 11, 14
 LPG 15, 46, 48, 84
 luminaires 78, 79, 95, 96

M

maintenance
 checklist 32, 94–6
 emergency escape lighting 7, 31, 32, 79, 83, 96
 equipment and machinery 17, 20, 32, 47–8
 escape routes 7, 25, 31, 32, 33, 96
 fire detection and warning systems 7, 31, 32, 34, 57, 83
 fire doors 31, 32, 96, 101
 firefighting equipment and facilities 7, 25, 31, 32, 34, 59–60, 62, 83, 96
 marquees 4, 8, 10, 15, 20, 40
 emergency escape lighting 78–9
 escape routes 22, 25, 26, 27, 28, 63, 64, 67, 70
 fire detection and warning systems 56
 firefighting equipment 23, 59
 flame-retardant materials 51–2
 smoking 50
 multi-use venues
 co-operation and co-ordination 38, 83, 86, 89
 escape routes 38, 80
 fire risk assessment 12, 83
 information and instruction 38, 56, 80, 84, 86
 music concerts 4, 19, 43, 55, 64, 82

N

naked flame 14, 20
non-English speakers 17, 37, 82, 84

O

oxygen, sources of 14, 16, 21, 33, 45, 84

P

partitions, fire-resisting 98, 99
see also walls
people at risk
 crowd control 26, 67, 86, 87
 evaluating 12, 18–19, 33, 50, 63–5, 68–70, 84
 identifying 13, 16–17, 34, 84, 85, 97
 removing or reducing risk 21–33, 34, 43, 53, 84, 97
 restricting the spread of fire and smoke 34, 51–3
 type and number using premises 22, 26, 27, 29, 40, 54, 64, 66–7, 68–70, 72, 75, 87
people with special needs
 evacuating 23, 25, 28, 29, 53–4, 67, 80, 85, 89, 91, 92
 fire risk assessment 6, 13, 17, 53–4, 84
 fire warning systems 55
 information and instruction 37, 80, 87, 88–9
 risk to 17
personal emergency evacuation plans (PEEPs) 54, 91
phased evacuation 23, 56–7, 105
piping 46, 51, 99
plans and specifications 35, 85
pneumatic structures 52, 70
portable appliance testing (PAT) 49
portakabins 65, 98
public address systems 32, 53–4, 55, 56, 61, 87
pyrotechnics 14, 15, 16, 20, 21, 45, 47

R

race meetings 4, 8, 11
radiation, fire spreading by 19, 64, 84
ramps 65, 67, 68
record-keeping
 emergency escape lighting 32, 79
 fire detection and warning systems 32, 34, 57, 83
 fire risk assessment 6, 8, 12, 13, 16, 32, 34–6, 38, 83, 84, 97
 fire safety training 83, 92
 firefighting equipment and facilities 32, 34, 83
refuges 67, 85, 105
risk
 definition 11
 evaluating 12, 13, 17–19, 33, 50, 63–5, 68–70, 84
 people at risk 13, 16–17, 33, 34, 63–5, 68–70, 84, 85, 97
 reducing 11, 13, 21–33, 34, 43, 84

S

scenery 15, 20, 52
seating 15, 40, 52, 64, 66, 76–7
security 53, 64, 89, 102
shared use *see* multi-use venues
short-term hiring or leasing 8, 89–90
shutters 51, 75, 96, 101, 104
signs and notices 26, 30–1, 33, 65, 80–2, 85, 94, 96
 information and instruction 24, 25, 62, 78, 86, 87
smoke
 control of 34, 51–3, 66, 98, 100, 101
 dangers of 19
 smoke and vapour effects 47, 87
 spread of 18, 19, 34, 77, 99
smoke detectors 72, 105
smoking 14, 15, 17, 20, 45, 50, 90
sporting events 4, 6, 64
sports grounds 4, 6, 8, 12, 66
sprinklers 96
staff
 fire drills 39, 40, 83, 91–2, 96
 fire safety training 7, 22, 28, 29, 37–8, 39–40, 54, 57, 85, 90–2, 96
 firefighting training 24, 38, 39, 58, 90, 91
 information and instruction 6, 7, 26, 28, 30–1, 34, 37–8, 56, 81, 84, 86, 88–9
 roles in emergency 23, 85, 88, 89, 90
 staff alarms 56
 staff numbers 32, 40, 54, 85
 temporary staff 7, 38
 see also contractors
stages 10, 16, 20, 45, 52, 64
storage 19, 20, 21, 44–7, 89

T

telephones 30, 31, 60
temporary staff 7, 38
temporary structures 8, 10, 16, 18, 20, 40, 45
 emergency escape lighting 78–9
 escape routes 22, 70, 74, 77
 fire detection and warning systems 22
 fire-resisting separation 98
 firefighting equipment 59
 smoking 50
 see also marquees
tents 11, 15, 20, 28, 51–2, 59, 64, 70, 84
theme parks 4, 11
torches 29, 32
training
 fire safety 7, 22, 28, 29, 34, 37–8, 39–40, 54, 57, 85, 90–2, 96
 firefighting equipment 24, 38, 39, 58, 90, 91
 record-keeping 83, 92

V

- vandalism 14, 21, 24, 60
- vegetation, fire risk of 15, 23, 45, 50, 53, 60, 84
- vehicles 15, 20, 23, 26, 53, 84
- vision panels 72, 100, 101
- voids 64, 99
- volunteers 4
 - escape routes 26, 28
 - fire drills 39, 40, 91
 - fire risk assessment 12, 17
 - fire safety training 22, 28, 29, 37–8, 39–40, 91
 - firefighting training 24, 39
 - information and instruction 6, 28, 37–8, 84
 - numbers 32

W





- walls
 - fire-resisting 51
 - lining materials 99–100
 - see also* partitions
- waste and packaging, combustible 15, 17–18, 20, 44, 45, 50, 53, 77, 84, 89
- windows, fire-resisting 99, 100
 - vision panels 72, 100, 101

Z

- zoos 4, 23, 87

This guide is for employers, managers, occupiers and owners of open air events and venues. It tells you what you have to do to comply with fire safety law, helps you to carry out a fire risk assessment and identify the general fire precautions you need to have in place.

The guides in this series:

Guide	Main use
 <i>Offices and shops</i> ISBN-13: 978 1 85112 815 0	Offices and retail premises (including individual units within larger premises, e.g. shopping centres).
 <i>Factories and warehouses</i> ISBN-13: 978 1 85112 816 7	Factories and warehouse storage premises.
 <i>Sleeping accommodation</i> ISBN-13: 978 1 85112 817 4	All premises where the main use is to provide sleeping accommodation, e.g. hotels, guest houses, B&Bs, hostels, residential training centres, holiday accommodation and the common areas of flats, maisonettes, HMOs and sheltered housing (other than those providing care – see Residential care premises), but excluding hospitals, residential care premises, places of custody and single private dwellings.
 <i>Residential care premises</i> ISBN-13: 978 1 85112 818 1	Residential care and nursing homes, common areas of sheltered housing (where care is provided) and similar premises, which are permanently staffed and where the primary use is the provision of care rather than healthcare (see Healthcare premises).
 <i>Educational premises</i> ISBN-13: 978 1 85112 819 8	Teaching establishments ranging from pre-school through to universities, except the residential parts (see Sleeping accommodation).
 <i>Small and medium places of assembly</i> ISBN-13: 978 1 85112 820 4	Smaller public houses, clubs, restaurants and cafés, village halls, community centres, libraries, marquees, churches and other places of worship or study accommodating up to 300 people.
 <i>Large places of assembly</i> ISBN-13: 978 1 85112 821 1	Larger premises where more than 300 people could gather, e.g. shopping centres (not the individual shops), large nightclubs and pubs, exhibition and conference centres, sports stadia, marquees, museums, libraries, churches, cathedrals and other places of worship or study.
 <i>Theatres, cinemas and similar premises</i> ISBN-13: 978 1 85112 822 8	Theatres, cinemas, concert halls and similar premises used primarily for this purpose.
 <i>Open air events and venues</i> ISBN-13: 978 1 85112 823 5	Open air events, e.g. theme parks, zoos, music concerts, sporting events (not stadia – see Large places of assembly), fairgrounds and county fairs.
 <i>Healthcare premises</i> ISBN-13: 978 1 85112 824 2	Premises where the primary use is the provision of healthcare (including private), e.g. hospitals, doctors' surgeries, dentists and other similar healthcare premises.
 <i>Transport premises and facilities</i> ISBN-13: 978 1 85112 825 9	Transportation terminals and interchanges, e.g. airports, railway stations (including sub-surface), transport tunnels, ports, bus and coach stations and similar premises but excluding the means of transport (e.g. trains, buses, planes and ships).

ISBN-13: 978 1 85112 823 5

Price: £12

ISBN 978185112823-5



9 781851 128235 >